

CUSTOM FLOW

ARCHITECTURAL SLOT DIFFUSER



CUSTOM FLOW

Architectural Slot Diffuser

Custom Flow (CF) slot diffusers are uniquely designed for curving and long continuous installations. The CF offers a large range of airflow flexibility with one or two slot arrangements, various slot widths, and vertical or horizontal pattern adjustment.

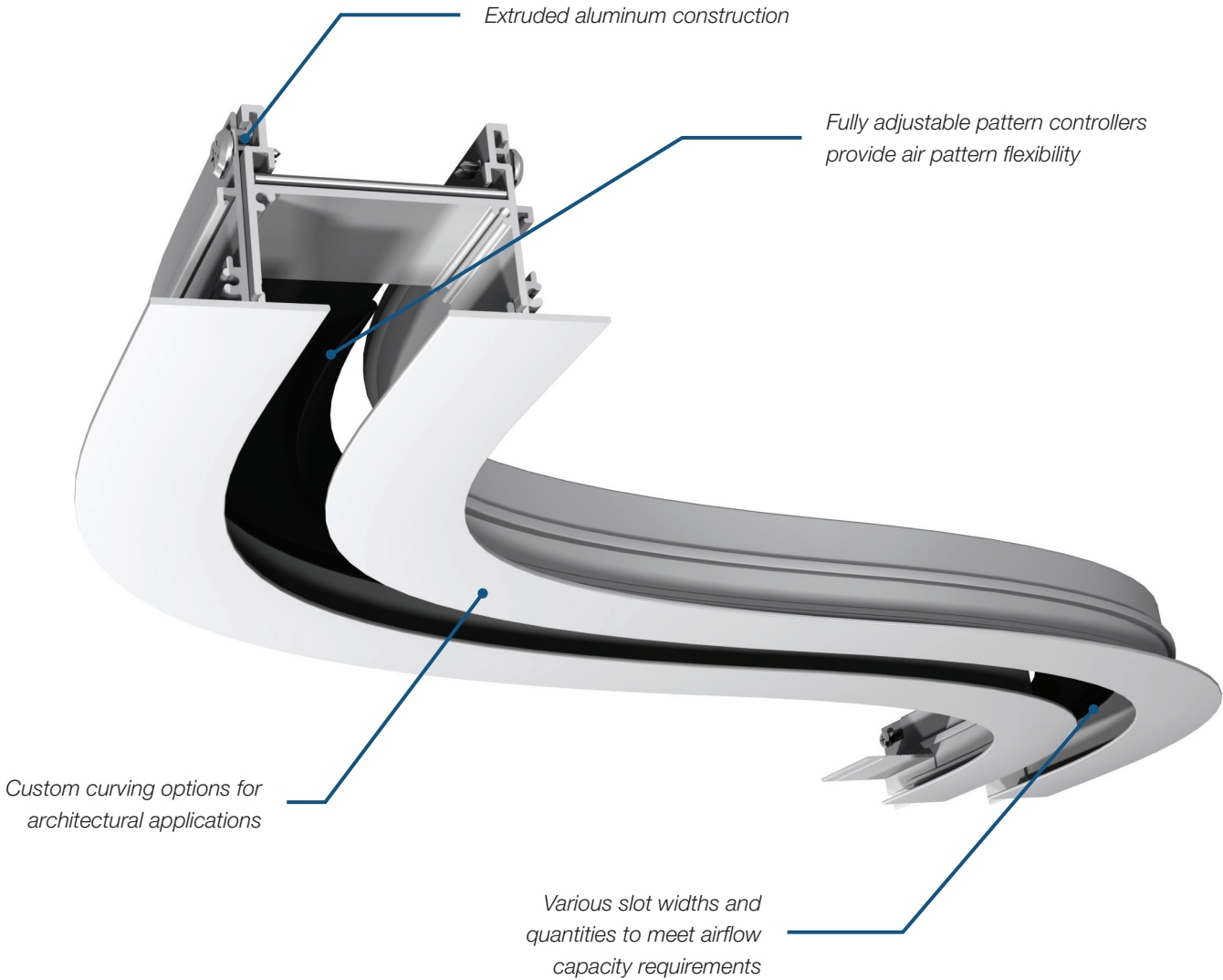

DESIGN FLEXIBILITY

Custom Flow diffusers feature extruded aluminum construction and are ideal for highly architectural applications. The CF is available with countless design options to provide ultimate flexibility, including:

- + Adjusta Slot (horizontal air pattern) and Jet Slot (vertical air pattern) pattern controller configurations to maximize air pattern performance.
- + Five slot widths for low, medium, and high capacity requirements.
- + Multiple frame styles including: exposed mounting, mud-in concealed frame, tegular and Techzone.
- + Discrete and continuous sections. Continuous installations are supplied with alignment strips for high quality architectural installations.
- + Flexible position for supply plenums, allowing active and return sections along the same diffuser. This is popular for continuous slot, perimeter applications.
- + Flat-faced, convex and concave curving sections that easily integrate with straight sections.
- + Flat, inside and outside mitered corners.
- + Assemblies can be easily trimmed to length on-site to meet exact room dimensions.
- + Multiple finish options, including anodized and wood-grain.

TYPICAL APPLICATIONS

Custom Flow linear diffusers are specifically designed for the most demanding architectural and performance applications. As a premium linear slot diffuser, Custom Flow is manufactured using extruded aluminum ensuring a crisp, clean appearance. Custom Flow is ideal for long, continuous runs and often used for perimeter heating and cooling.

CONSTRUCTION

- + Pattern Controller Style
 - Adjusta Slot
 - Jet Slot
 - Return
- + Slot Widths
 - 1 in.
 - 1 ½ in.
 - 2 in.
 - 2 ½ in.
 - 3 in.
- + Slot quantity
 - 1 or 2

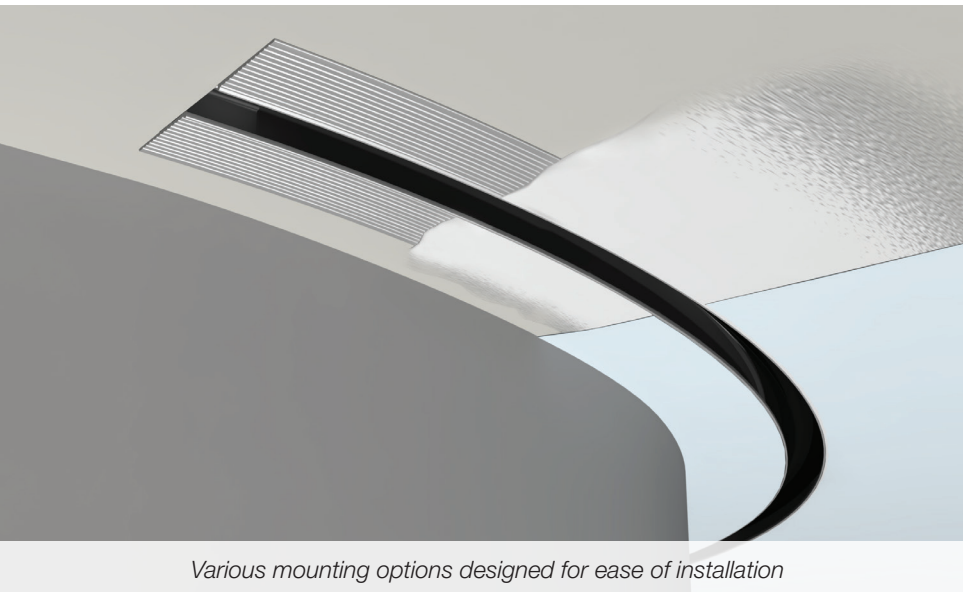

Various mounting options designed for ease of installation

PATTERN CONTROLLER STYLE

Custom Flow diffusers offer superior performance and function, featuring dual layered pattern controllers for full airflow adjustment, dampering and blank-off capabilities. The pattern controllers are provided in section lengths up to 24 in.; this feature provides multiple pattern and airflow possibilities along the length of a continuous diffuser. Pattern controller styles may be selected for optimal horizontal (Adjusta Slot) or vertical (Jet Slot) airflow performance.

Adjusta-slot (AS)

- + Adjusta-slot pattern controllers are designed for ceiling installations and produce a strong, horizontal air pattern over a wide range of airflows.
- + Adjusta-slot units are particularly well suited for open office perimeter zones, main floor entrance foyers and lobbies, elevator lobbies, conference rooms, mall atriums and theatres. Continuous installations are typically located at the perimeter of a zone in which a large air volume must be introduced.

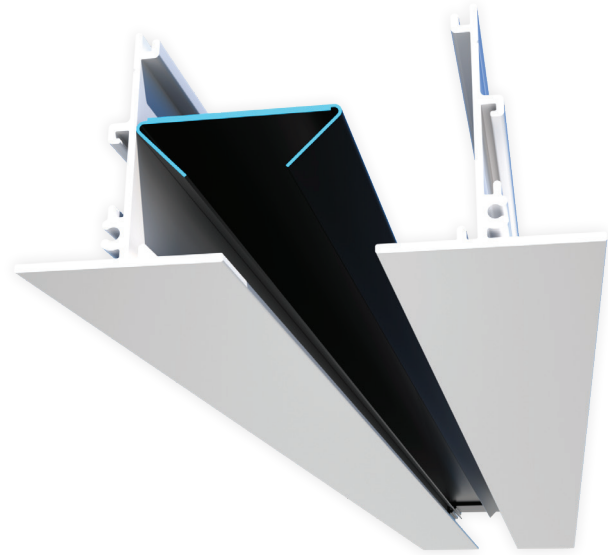

One slot air pattern adjustment

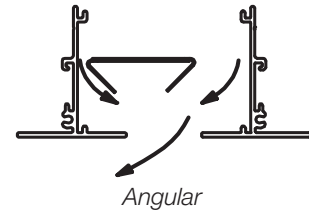
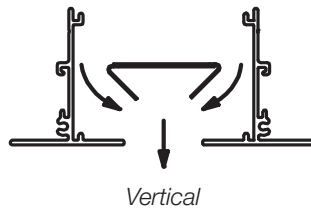
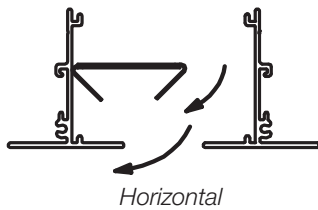

Two slot air pattern adjustment (may differ for each slot)

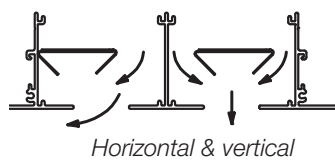
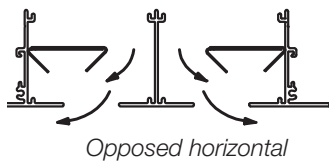

Volume adjustments

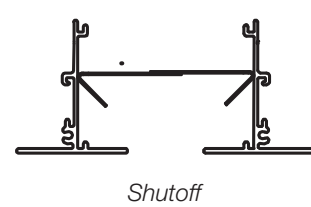
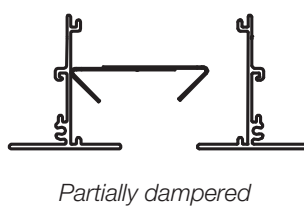
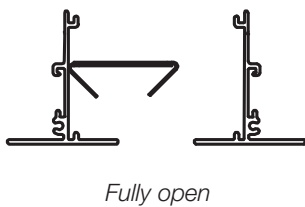

CUSTOM FLOW

Architectural Slot Diffuser

Jet-slot (JS)

- + Jet-slot pattern controllers are designed to provide a strong vertical air pattern perpendicular to the diffuser face.
- + Jet-slot diffusers are ideal for projecting conditioned air down a high perimeter window where it is necessary for airflow to reach the floor to prevent stagnant zones, as well as interior zones with unusually high ceilings, such as auditoriums, entrance foyers, mall atriums, convention centers and theaters.

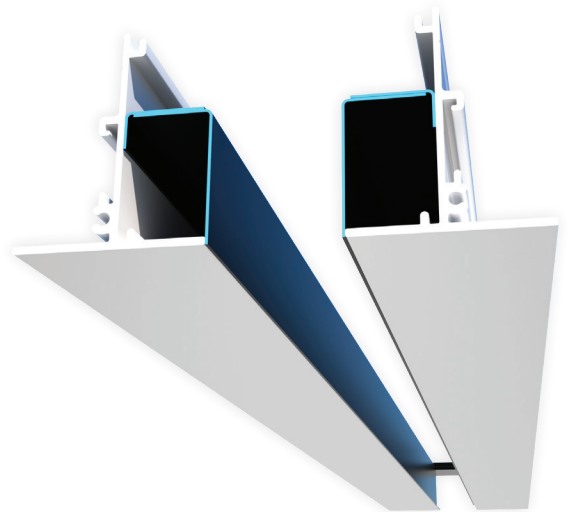

One slot air pattern adjustment

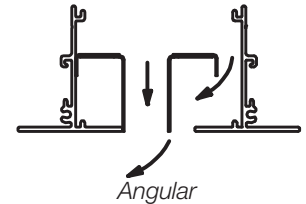
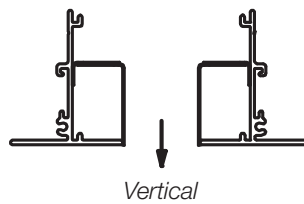
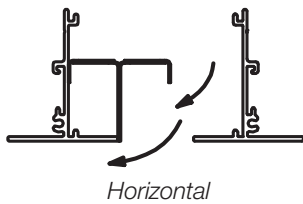

Two slot air pattern adjustment (may differ for each slot)

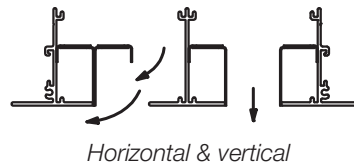
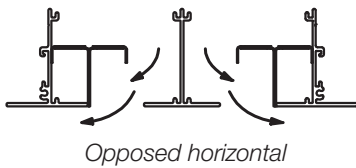

Volume adjustments

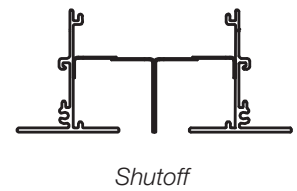
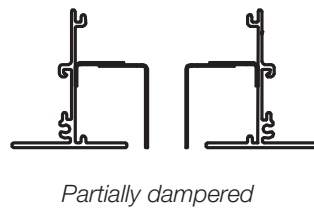
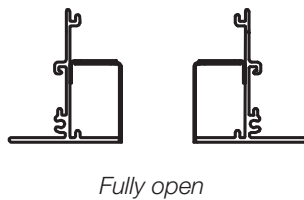

OPTIONAL ACCESSORIES

- + Custom Flow Architectural Slot Diffusers are available with an assortment of accessories including:
 - Return Air Sight Baffle
 - Metal Blank-Offs

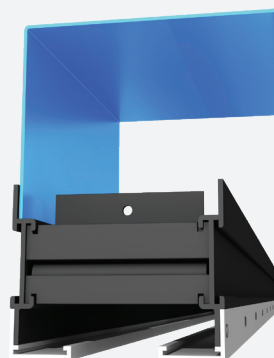

Sight Baffle

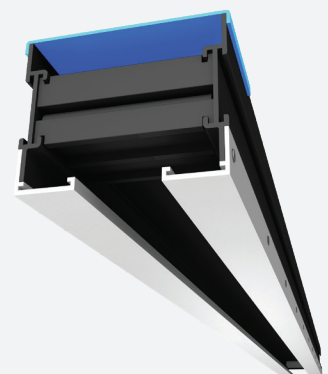

Blank-Off

CONFIGURATION OPTIONS

Frame Style

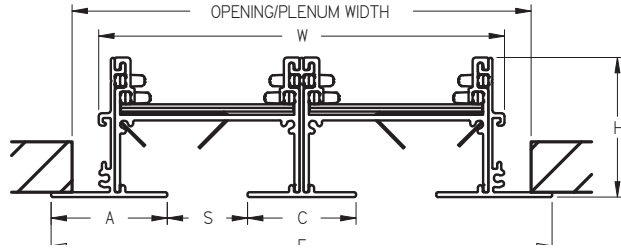

EF - EXPOSED FRAME

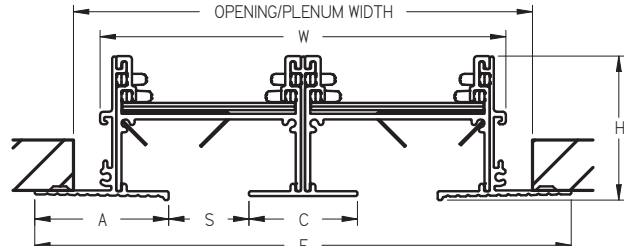

CMF - CONCEALED MOUNTING FRAME

Mounting

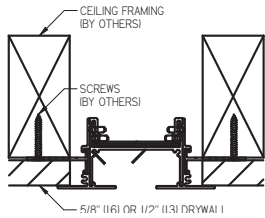

MP-DR - REVERSIBLE DRYWALL MOUNTING CLIP (SM ONLY)

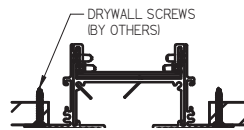

A - COUNTERSUNK HOLES (CMF ONLY)

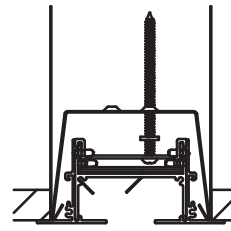

C - CONCEALED MOUNTING BRACKET (SM ONLY)

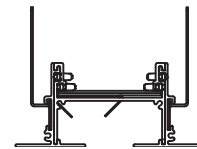

HB - HANGER BRACKETS (LI ONLY)

End Conditions

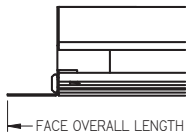

W - FLANGED END (EF ONLY)

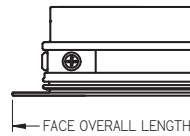

X - MITRED END

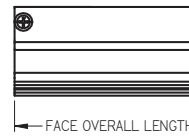

Y - OPEN END

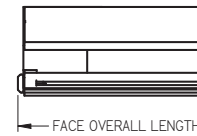

Z - FLUSH END

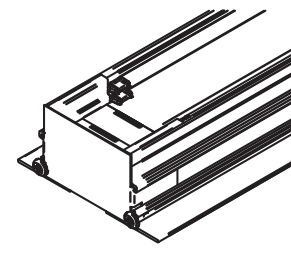
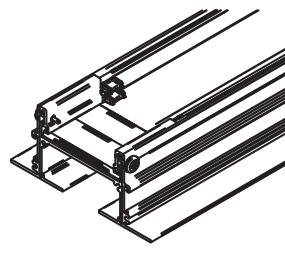
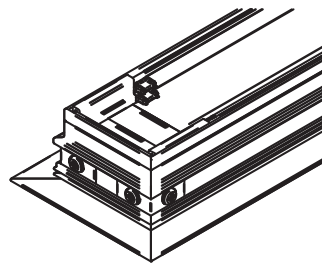
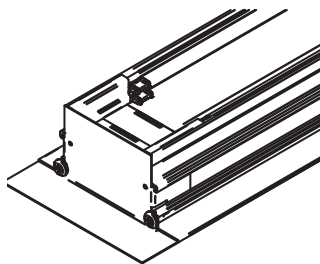

CURVED LINEAR SLOT DIFFUSER (CFC)

- + Curved Custom Flow diffusers are available in flat-in-plane, concave or convex curves for supply or return applications making them ideal for highly architectural projects.
- + With fully adjustable pattern controllers, airflow adjustment remains flexible, even after curving.
- + Factory built plenums are an available option, built to suit the curvature of the diffuser, minimizing complications due to custom field fabrication and mounting.

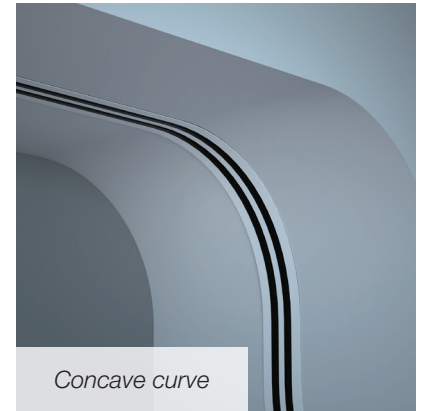
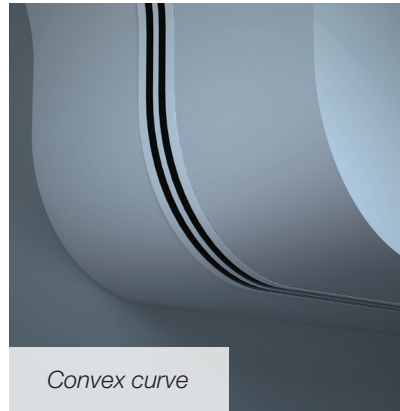
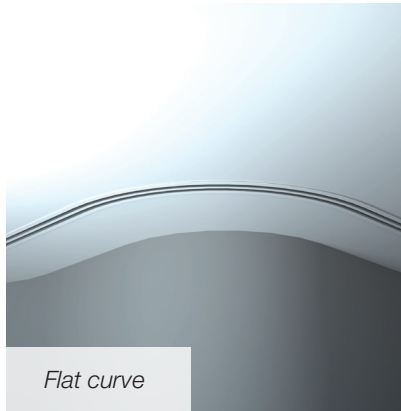

CUSTOM FLOW PLENUMS (CFP)

- + Price offers factory built and tested plenum assemblies in various sizes and configurations. To ensure on-site performance matches published performance data, factory built plenums are necessary.
- + Optional fiberglass or fiber free foam plenum insulation is available.

Curved plenum



CONSTRUCTION

- + Style
 - Straight
 - Curved
- + Length
 - 24 in.
 - 36 in.
 - 48 in.
 - 60 in.
- + Mounting Type
 - Surface mount
 - T-bar lay-in
- + Insulation
 - Fiberglass
 - Fiber free foam
- + Options
 - Cable operated damper (VCR8EC)

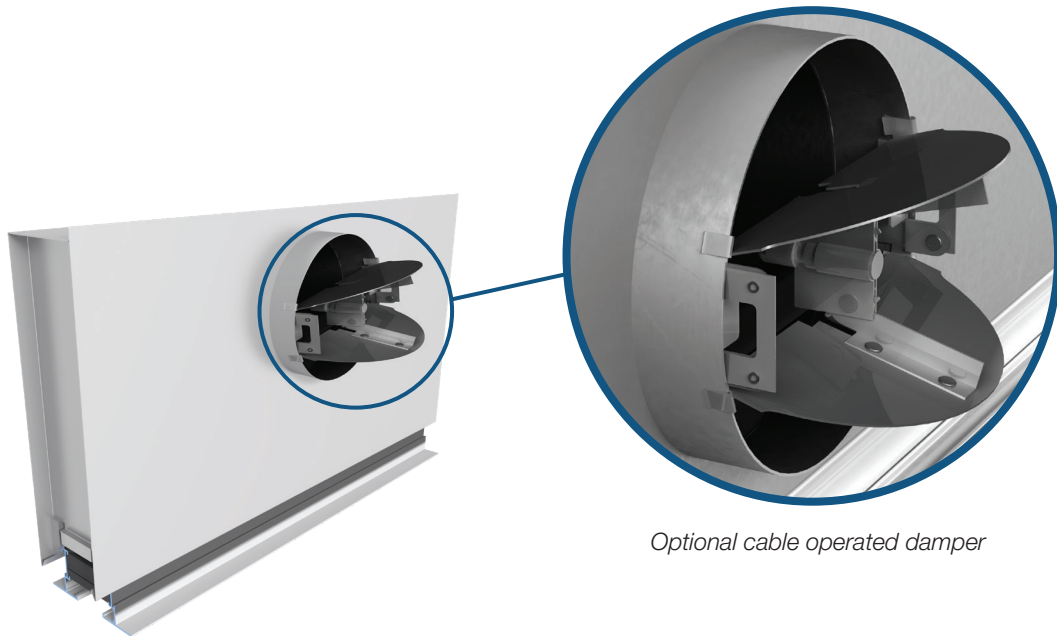

Optional cable operated damper

MODULAR CUSTOM FLOW DIFFUSER (ASM)

- + Adjusta-slot Modular 4-sided single slot diffuser provides a unique architectural look and allows a matching ceiling tile to be used on the interior of the diffuser for visual consistency within the space.
- + ASM diffusers are designed for most Lay-in suspension systems with a nominal module size of 24 in. x 24 in. and a 1 in. slot.
- + Each slot can be field adjusted from the face of the diffuser to provide horizontal or vertical air patterns.

CONSTRUCTION

- + Application
 - Supply
 - Return
- + Size
 - 24 in. x 24 in.
- + Mounting
 - T-bar
 - Bolt slot
- + Options
 - Insulated plenum

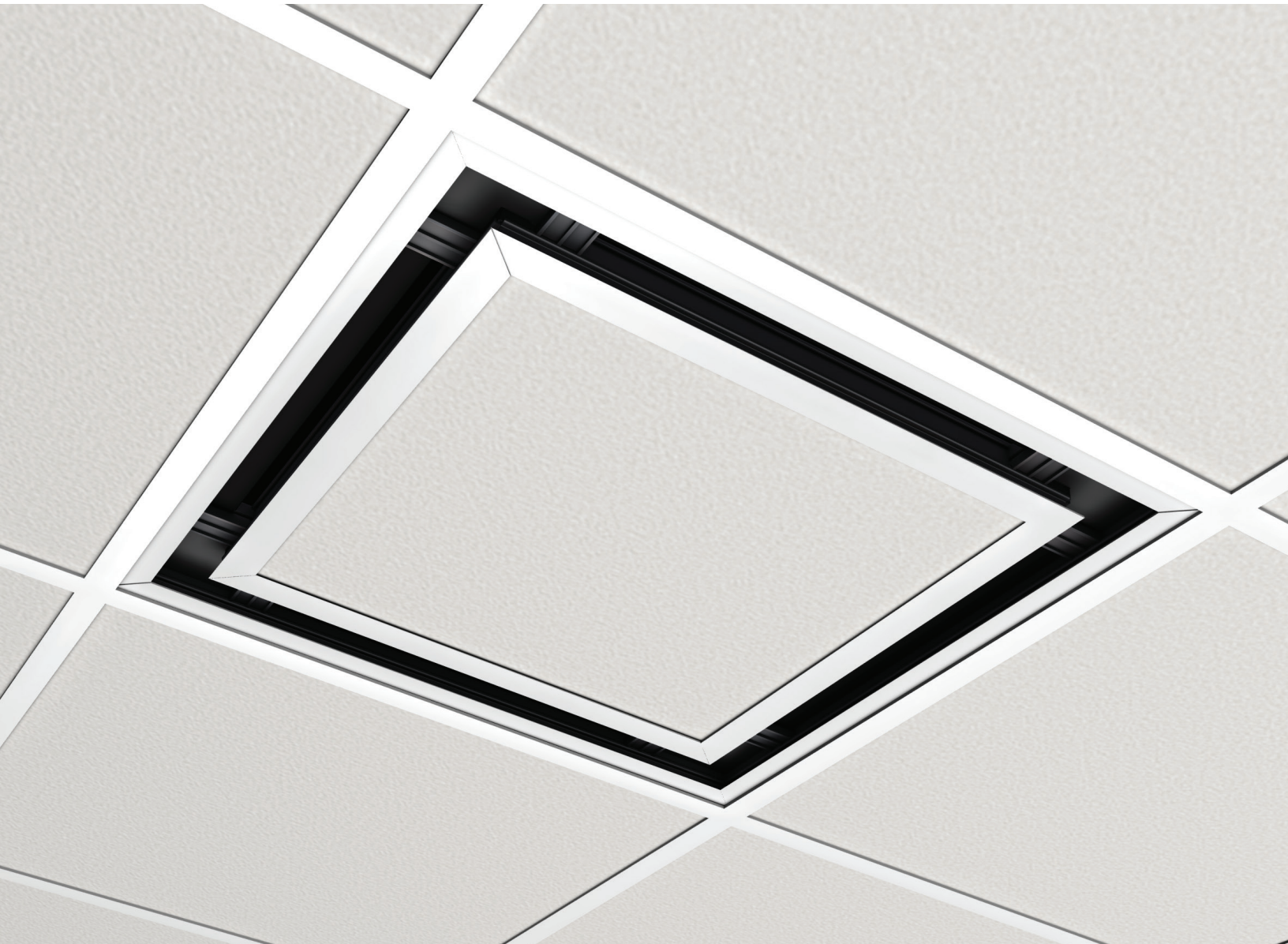

PERFORMANCE DATA

AS with Pressurized Ceiling Plenum (Non-Ducted)

1.0 in. Slot Width	1 Slot	Flow Rate (cfm/ft) Static Pressure (in. w.g.) Sound (NC) Throw (ft)	25 0.01 --- 6-9-17	40 0.05 19 9-14-24	55 0.15 27 13-19-28	70 0.25 34 16-23-32	85 0.34 39 19-25-35	100 0.44 44 22-27-38	115 0.54 49 24-29-41
	2 Slot	Flow Rate (cfm/ft) Static Pressure (in. w.g.) Sound (NC) Throw (ft)	50 0.01 --- 9-15-24	75 0.06 23 15-20-29	100 0.13 30 19-24-33	125 0.21 36 22-26-37	150 0.28 41 24-29-41	175 0.36 45 25-31-44	200 0.43 49 27-33-47
1.5 in. Slot Width	1 Slot	Flow Rate (cfm/ft) Static Pressure (in. w.g.) Sound (NC) Throw (ft)	30 0.01 --- 5-8-17	45 0.05 17 8-13-24	60 0.14 25 11-17-28	75 0.22 31 14-21-31	90 0.31 36 17-24-34	105 0.39 42 20-26-37	120 0.48 47 23-28-39
	2 Slot	Flow Rate (cfm/ft) Static Pressure (in. w.g.) Sound (NC) Throw (ft)	60 0.01 --- 7-13-24	85 0.06 21 13-19-28	110 0.13 28 16-23-32	135 0.19 34 20-25-35	160 0.26 38 22-27-39	185 0.32 43 24-29-42	210 0.39 48 26-31-44
2.0 in. Slot Width	1 Slot	Flow Rate (cfm/ft) Static Pressure (in. w.g.) Sound (NC) Throw (ft)	30 0.01 --- 3-7-15	50 0.01 17 8-12-24	70 0.09 21 11-17-28	90 0.17 28 15-22-32	110 0.24 34 18-25-35	130 0.32 40 21-27-38	150 0.40 45 24-29-41
	2 Slot	Flow Rate (cfm/ft) Static Pressure (in. w.g.) Sound (NC) Throw (ft)	60 0.01 --- 5-10-21	95 0.02 17 11-16-27	130 0.08 24 15-22-32	165 0.15 31 19-25-36	200 0.21 37 23-28-39	235 0.27 42 25-30-42	270 0.34 47 26-32-45
2.5 in. Slot Width	1 Slot	Flow Rate (cfm/ft) Static Pressure (in. w.g.) Sound (NC) Throw (ft)	30 0.01 --- 2-5-13	55 0.01 --- 8-12-23	80 0.07 20 12-17-28	105 0.14 28 15-23-32	130 0.22 34 19-25-35	155 0.29 40 22-27-39	180 0.37 44 24-29-42
	2 Slot	Flow Rate (cfm/ft) Static Pressure (in. w.g.) Sound (NC) Throw (ft)	60 0.01 --- 4-8-17	105 0.01 16 10-14-25	150 0.06 23 14-21-30	195 0.13 31 18-25-35	240 0.19 38 22-27-39	285 0.25 43 24-30-42	330 0.31 48 26-32-45
3.0 in. Slot Width	1 Slot	Flow Rate (cfm/ft) Static Pressure (in. w.g.) Sound (NC) Throw (ft)	30 0.01 --- 2-4-12	60 0.01 --- 7-12-22	90 0.06 20 12-18-27	120 0.13 28 16-22-31	150 0.21 35 20-25-35	180 0.28 40 22-27-39	210 0.35 45 24-29-42
	2 Slot	Flow Rate (cfm/ft) Static Pressure (in. w.g.) Sound (NC) Throw (ft)	60 0.01 --- 3-7-13	120 0.01 16 9-13-24	180 0.07 25 13-20-30	240 0.13 34 18-24-34	300 0.20 41 22-27-38	360 0.27 46 24-30-42	420 0.34 51 26-32-45

Performance Notes:

1. Testing in accordance with ASHRAE Standard 70-2006 "Method of Testing for Rating the Performance of Air Outlets and Inlets."
2. Data is based on pressurized ceiling plenum application with no plenum effect for pressure or sound.
3. All pressures are in in. w.g.
4. Throw values are measured in feet for terminal velocities of 150 fpm (minimum), 100 fpm (middle) and 50 fpm (maximum).
5. Throw data is based on active sections 4 ft long. For other lengths refer to Table A.
6. Throw data is based on supply air and room air being at isothermal conditions.
7. Throw values are based on 1 way air pattern. For 2 way pattern, throw is determined from the 1-slot data at 1/2 the specified air volume.
8. NC values are based on a room absorption of 10 dB, re 10⁻¹² watts, for a 4 ft section. For other lengths refer to Table B.
9. For supply units used as a return add 3 NC.
10. Blanks "-" indicate an NC level below 15.

Table A. Throw Correction Multiplier for Length

Length, ft	2	4	8	12
Throw Correction	0.9	1.0	1.1	1.1

Table B. NC Correction for Length

Length, ft	2	4	6	8	10
Supply	-4	0	3	5	7
Return	0	3	5	6	8

PERFORMANCE DATA

24" Length – 1 Slot AS with Engineered Plenum (CFP)
EF, CMF, FM, TG916, TZ, and Hybrid Frames

1.0 in. Slot Width	1 Slot 6 in. Inlet	Flow Rate (cfm)	25	45	65	85	105	125	145	165	185
		Total Pressure (in. w.g.)	0.011	0.037	0.077	0.131	0.200	0.283	0.381	0.494	0.621
	1 Slot 8 in. Inlet	Flow Rate (cfm)	25	45	65	85	105	125	145	165	185
		Total Pressure (in. w.g.)	0.010	0.033	0.070	0.119	0.182	0.258	0.347	0.449	0.565
	1 Slot 10 in. Oval Inlet	Flow Rate (cfm)	25	45	65	85	105	125	145	165	185
		Total Pressure (in. w.g.)	0.010	0.032	0.067	0.114	0.174	0.247	0.332	0.430	0.541
1 Slot 12" Oval Inlet	Flow Rate (cfm)	25	45	65	85	105	125	145	165	185	
	Total Pressure (in. w.g.)	0.010	0.032	0.066	0.114	0.173	0.246	0.331	0.428	0.538	
1.5" Slot Width	1 Slot 6" Inlet	Flow Rate (cfm)	35	55	75	95	115	135	155	175	195
		Total Pressure (in. w.g.)	0.018	0.044	0.082	0.131	0.192	0.264	0.348	0.444	0.551
	1 Slot 8" Inlet	Flow Rate (cfm)	35	55	75	95	115	135	155	175	195
		Total Pressure (in. w.g.)	0.015	0.037	0.070	0.112	0.163	0.225	0.297	0.378	0.470
	1 Slot 10" Oval Inlet	Flow Rate (cfm)	35	55	75	95	115	135	155	175	195
		Total Pressure (in. w.g.)	0.015	0.037	0.069	0.110	0.161	0.222	0.293	0.374	0.464
1 Slot 12" Oval Inlet	Flow Rate (cfm)	35	55	75	95	115	135	155	175	195	
	Total Pressure (in. w.g.)	0.015	0.037	0.068	0.109	0.160	0.221	0.291	0.371	0.461	
1.5" Slot Width	1 Slot 6" Inlet	Flow Rate (cfm)	35	55	75	95	115	135	155	175	195
		Total Pressure (in. w.g.)	0.015	0.037	0.069	0.110	0.161	0.222	0.293	0.374	0.464
	1 Slot 8" Inlet	Flow Rate (cfm)	35	55	75	95	115	135	155	175	195
		Total Pressure (in. w.g.)	0.015	0.037	0.069	0.110	0.161	0.222	0.293	0.374	0.464
	1 Slot 10" Inlet	Flow Rate (cfm)	35	55	75	95	115	135	155	175	195
		Total Pressure (in. w.g.)	0.015	0.037	0.069	0.110	0.161	0.222	0.293	0.374	0.464
1 Slot 12" Inlet	Flow Rate (cfm)	35	55	75	95	115	135	155	175	195	
	Total Pressure (in. w.g.)	0.015	0.037	0.068	0.109	0.160	0.221	0.291	0.371	0.461	

PERFORMANCE DATA

24" Length – 1 Slot AS with Engineered Plenum (CFP)

EF, CMF, FM, TG916, TZ, and Hybrid Frames

2.0" Slot Width	1 Slot 8" Inlet	Flow Rate (cfm)	40	70	100	130	160	190	220	250	280
		Total Pressure (in. w.g.)	0.011	0.032	0.066	0.111	0.168	0.237	0.318	0.411	0.515
		Static Pressure (in. w.g.)	0.010	0.030	0.061	0.102	0.155	0.219	0.293	0.379	0.475
	1 Slot 10" Oval Inlet	Flow Rate (cfm)	40	70	100	130	160	190	220	250	280
		Total Pressure (in. w.g.)	0.010	0.030	0.062	0.104	0.158	0.222	0.298	0.385	0.483
		Static Pressure (in. w.g.)	0.009	0.029	0.059	0.100	0.152	0.214	0.287	0.370	0.464
	1 Slot 10" Inlet	Flow Rate (cfm)	40	70	100	130	160	190	220	250	280
		Total Pressure (in. w.g.)	0.010	0.030	0.061	0.103	0.157	0.221	0.296	0.382	0.480
		Static Pressure (in. w.g.)	0.009	0.029	0.059	0.100	0.151	0.213	0.286	0.369	0.463
	1 Slot 12" Oval Inlet	Flow Rate (cfm)	40	70	100	130	160	190	220	250	280
		Total Pressure (in. w.g.)	0.010	0.029	0.060	0.101	0.154	0.217	0.290	0.375	0.470
		Static Pressure (in. w.g.)	0.009	0.029	0.059	0.099	0.150	0.212	0.284	0.367	0.460
1 Slot 12" Inlet	Flow Rate (cfm)	40	70	100	130	160	190	220	250	280	
	Total Pressure (in. w.g.)	0.010	0.029	0.059	0.100	0.152	0.215	0.288	0.372	0.466	
	Static Pressure (in. w.g.)	0.009	0.029	0.058	0.099	0.150	0.211	0.283	0.365	0.458	
2.5" Slot Width	1 Slot 10" Oval Inlet	Flow Rate (cfm)	45	80	115	150	185	220	255	290	325
		Total Pressure (in. w.g.)	0.008	0.024	0.050	0.084	0.128	0.182	0.244	0.315	0.396
		Static Pressure (in. w.g.)	0.007	0.023	0.047	0.079	0.120	0.170	0.229	0.296	0.372
	1 Slot 10" Inlet	Flow Rate (cfm)	45	80	115	150	185	220	255	290	325
		Total Pressure (in. w.g.)	0.008	0.024	0.049	0.084	0.127	0.180	0.242	0.312	0.392
		Static Pressure (in. w.g.)	0.007	0.022	0.046	0.079	0.120	0.170	0.228	0.295	0.370
	1 Slot 12" Oval Inlet	Flow Rate (cfm)	45	80	115	150	185	220	255	290	325
		Total Pressure (in. w.g.)	0.007	0.023	0.048	0.081	0.123	0.174	0.234	0.303	0.380
		Static Pressure (in. w.g.)	0.007	0.022	0.046	0.078	0.119	0.168	0.225	0.292	0.366
	1 Slot 12" Inlet	Flow Rate (cfm)	45	80	115	150	185	220	255	290	325
		Total Pressure (in. w.g.)	0.007	0.023	0.047	0.080	0.121	0.172	0.231	0.299	0.375
		Static Pressure (in. w.g.)	0.007	0.022	0.046	0.078	0.118	0.167	0.224	0.290	0.364
3.0" Slot Width	1 Slot 10" Oval Inlet	Flow Rate (cfm)	50	90	130	170	210	250	290	330	370
		Total Pressure (in. w.g.)	0.006	0.021	0.044	0.075	0.114	0.161	0.217	0.281	0.353
		Static Pressure (in. w.g.)	0.006	0.019	0.040	0.068	0.103	0.147	0.197	0.255	0.321
	1 Slot 10" Inlet	Flow Rate (cfm)	50	90	130	170	210	250	290	330	370
		Total Pressure (in. w.g.)	0.006	0.021	0.043	0.074	0.112	0.159	0.214	0.277	0.348
		Static Pressure (in. w.g.)	0.006	0.019	0.039	0.067	0.103	0.146	0.196	0.254	0.320
	1 Slot 12" Oval Inlet	Flow Rate (cfm)	50	90	130	170	210	250	290	330	370
		Total Pressure (in. w.g.)	0.006	0.020	0.041	0.070	0.107	0.152	0.205	0.265	0.333
		Static Pressure (in. w.g.)	0.006	0.019	0.039	0.066	0.101	0.144	0.193	0.250	0.315
	1 Slot 12" Inlet	Flow Rate (cfm)	50	90	130	170	210	250	290	330	370
		Total Pressure (in. w.g.)	0.006	0.019	0.040	0.069	0.105	0.149	0.201	0.260	0.326
		Static Pressure (in. w.g.)	0.006	0.018	0.039	0.066	0.101	0.143	0.192	0.249	0.313

For performance notes, see end of section

PERFORMANCE DATA

48" Length – 1 Slot AS with Engineered Plenum (CFP)

EF, CMF, FM, TG916, TZ, and Hybrid Frames

1.0" Slot Width	1 Slot 6" Inlet	Flow Rate (cfm)	60	90	120	150	180	210	240	270	300
		Total Pressure (in. w.g.)	0.021	0.046	0.082	0.128	0.185	0.252	0.329	0.416	0.514
	1 Slot 8" Inlet	Flow Rate (cfm)	60	95	130	165	200	235	270	305	340
		Total Pressure (in. w.g.)	0.015	0.038	0.071	0.114	0.167	0.231	0.304	0.388	0.483
	1 Slot 10" Oval Inlet	Flow Rate (cfm)	60	95	130	165	200	235	270	305	340
		Total Pressure (in. w.g.)	0.014	0.034	0.064	0.103	0.151	0.208	0.275	0.351	0.436
1 Slot 12" Oval Inlet	Flow Rate (cfm)	60	95	130	165	200	235	270	305	340	
	Total Pressure (in. w.g.)	0.013	0.032	0.060	0.096	0.142	0.196	0.258	0.329	0.409	
1.5" Slot Width	1 Slot 6" Inlet	Flow Rate (cfm)	75	105	135	165	195	225	255	285	315
		Total Pressure (in. w.g.)	0.028	0.054	0.089	0.133	0.186	0.248	0.319	0.398	0.486
	1 Slot 8" Inlet	Flow Rate (cfm)	75	110	145	180	215	250	285	320	355
		Total Pressure (in. w.g.)	0.019	0.041	0.071	0.109	0.156	0.211	0.275	0.346	0.426
	1 Slot 10" Oval Inlet	Flow Rate (cfm)	75	110	145	180	215	250	285	320	355
		Total Pressure (in. w.g.)	0.017	0.036	0.063	0.097	0.138	0.187	0.242	0.306	0.376
1 Slot 12" Oval Inlet	Flow Rate (cfm)	75	110	145	180	215	250	285	320	355	
	Total Pressure (in. w.g.)	0.016	0.035	0.060	0.093	0.133	0.179	0.233	0.294	0.361	
1.5" Slot Width	1 Slot 6" Inlet	Flow Rate (cfm)	75	105	135	165	195	225	255	285	315
		Total Pressure (in. w.g.)	0.018	0.036	0.060	0.089	0.125	0.166	0.213	0.266	0.325
	1 Slot 8" Inlet	Flow Rate (cfm)	75	110	145	180	215	250	285	320	355
		Total Pressure (in. w.g.)	0.015	0.033	0.058	0.089	0.127	0.172	0.223	0.282	0.347
	1 Slot 10" Inlet	Flow Rate (cfm)	75	110	145	180	215	250	285	320	355
		Total Pressure (in. w.g.)	0.015	0.033	0.058	0.089	0.127	0.171	0.223	0.281	0.345
1 Slot 12" Inlet	Flow Rate (cfm)	75	110	145	180	215	250	285	320	355	
	Total Pressure (in. w.g.)	0.016	0.034	0.060	0.092	0.131	0.177	0.230	0.290	0.358	
1.5" Slot Width	1 Slot 6" Inlet	Flow Rate (cfm)	75	105	135	165	195	225	255	285	315
		Total Pressure (in. w.g.)	0.015	0.033	0.057	0.088	0.125	0.169	0.220	0.277	0.341
	1 Slot 8" Inlet	Flow Rate (cfm)	75	110	145	180	215	250	285	320	355
		Total Pressure (in. w.g.)	0.015	0.032	0.056	0.087	0.124	0.168	0.218	0.275	0.338
	1 Slot 10" Inlet	Flow Rate (cfm)	75	110	145	180	215	250	285	320	355
		Total Pressure (in. w.g.)	0.016	0.034	0.060	0.092	0.131	0.177	0.230	0.290	0.358
1 Slot 12" Inlet	Flow Rate (cfm)	75	110	145	180	215	250	285	320	355	
	Total Pressure (in. w.g.)	0.015	0.032	0.056	0.087	0.124	0.168	0.218	0.275	0.338	

PERFORMANCE DATA

48" Length – 1 Slot AS with Engineered Plenum (CFP)

EF, CMF, FM, TG916, TZ, and Hybrid Frames

2.0" Slot Width	1 Slot 8" Inlet	Flow Rate (cfm)	85	130	175	220	265	310	355	400	445
		Total Pressure (in. w.g.)	0.014	0.034	0.061	0.096	0.140	0.191	0.251	0.318	0.394
		Static Pressure (in. w.g.)	0.011	0.025	0.045	0.071	0.104	0.142	0.186	0.236	0.292
	1 Slot 10" Oval Inlet	Sound (NC)	-	-	-	21	27	32	36	40	43
		Throw (ft)	2-4-10	4-8-16	7-11-22	9-14-25	11-16-27	13-19-29	15-22-32	16-24-33	18-25-35
		Flow Rate (cfm)	85	135	185	235	285	335	385	435	485
	1 Slot 10" Inlet	Total Pressure (in. w.g.)	0.012	0.029	0.055	0.089	0.130	0.180	0.238	0.304	0.378
		Static Pressure (in. w.g.)	0.010	0.025	0.047	0.076	0.111	0.154	0.203	0.259	0.323
		Sound (NC)	-	-	-	20	26	31	36	40	43
	1 Slot 12" Oval Inlet	Throw (ft)	2-4-10	4-8-17	8-11-23	10-14-26	12-18-28	14-21-31	16-23-33	18-25-35	20-26-37
		Flow Rate (cfm)	85	135	185	235	285	335	385	435	485
		Total Pressure (in. w.g.)	0.011	0.027	0.050	0.081	0.119	0.164	0.217	0.277	0.344
1 Slot 12" Inlet	Static Pressure (in. w.g.)	0.010	0.024	0.045	0.073	0.108	0.149	0.197	0.252	0.313	
	Sound (NC)	-	-	-	19	25	30	35	39	42	
	Throw (ft)	2-4-10	4-8-17	8-11-23	10-14-26	12-18-28	14-21-31	16-23-33	18-25-35	20-26-37	
1 Slot 12" Inlet	Flow Rate (cfm)	85	135	185	235	285	335	385	435	485	
	Total Pressure (in. w.g.)	0.010	0.026	0.048	0.078	0.115	0.159	0.210	0.268	0.333	
	Static Pressure (in. w.g.)	0.009	0.024	0.045	0.073	0.107	0.148	0.195	0.249	0.309	
2.5" Slot Width	1 Slot 10" Oval Inlet	Sound (NC)	-	-	-	18	25	30	34	38	42
		Throw (ft)	1-3-12	4-8-20	7-14-27	11-17-30	14-21-33	16-24-36	19-27-38	21-29-41	24-30-43
		Flow Rate (cfm)	95	155	215	275	335	395	455	515	575
	1 Slot 10" Inlet	Total Pressure (in. w.g.)	0.010	0.026	0.050	0.081	0.121	0.168	0.222	0.285	0.355
		Static Pressure (in. w.g.)	0.008	0.020	0.039	0.064	0.094	0.131	0.174	0.223	0.278
		Sound (NC)	-	-	-	20	26	31	36	40	43
	1 Slot 12" Oval Inlet	Throw (ft)	1-3-10	4-8-17	8-12-23	10-15-26	12-18-28	14-21-31	16-23-33	19-25-35	21-26-37
		Flow Rate (cfm)	95	155	215	275	335	395	455	515	575
		Total Pressure (in. w.g.)	0.009	0.025	0.048	0.079	0.117	0.162	0.216	0.276	0.344
	1 Slot 12" Inlet	Static Pressure (in. w.g.)	0.008	0.020	0.038	0.063	0.093	0.130	0.172	0.221	0.275
		Sound (NC)	-	-	-	19	26	31	35	39	43
		Throw (ft)	1-3-10	4-8-17	8-12-23	10-15-26	12-18-28	14-21-31	16-23-33	19-25-35	21-26-37
1 Slot 12" Inlet	Flow Rate (cfm)	95	155	215	275	335	395	455	515	575	
	Total Pressure (in. w.g.)	0.008	0.022	0.043	0.071	0.105	0.146	0.194	0.248	0.309	
	Static Pressure (in. w.g.)	0.007	0.019	0.037	0.061	0.090	0.125	0.166	0.213	0.265	
3.0" Slot Width	1 Slot 10" Oval Inlet	Sound (NC)	-	-	-	18	24	30	34	38	42
		Throw (ft)	1-3-10	4-8-17	8-12-23	10-15-26	12-18-28	14-21-31	16-23-33	19-25-35	21-26-37
		Flow Rate (cfm)	105	175	245	315	385	455	525	595	665
	1 Slot 10" Inlet	Total Pressure (in. w.g.)	0.009	0.025	0.049	0.081	0.121	0.169	0.225	0.289	0.361
		Static Pressure (in. w.g.)	0.006	0.018	0.035	0.058	0.086	0.120	0.160	0.206	0.257
		Sound (NC)	-	-	-	21	27	32	37	41	45
	1 Slot 12" Oval Inlet	Throw (ft)	1-3-10	4-9-17	8-12-22	10-15-25	13-19-28	15-22-31	17-23-33	19-25-35	21-26-37
		Flow Rate (cfm)	105	175	245	315	385	455	525	595	665
		Total Pressure (in. w.g.)	0.009	0.024	0.047	0.078	0.116	0.162	0.216	0.277	0.346
	1 Slot 12" Inlet	Static Pressure (in. w.g.)	0.006	0.018	0.034	0.057	0.085	0.119	0.158	0.203	0.253
		Sound (NC)	-	-	-	20	26	32	36	40	44
		Throw (ft)	1-3-10	4-9-17	8-12-22	10-15-25	13-19-28	15-22-31	17-23-33	19-25-35	21-26-37
1 Slot 12" Inlet	Flow Rate (cfm)	105	175	245	315	385	455	525	595	665	
	Total Pressure (in. w.g.)	0.007	0.021	0.041	0.067	0.101	0.140	0.187	0.240	0.300	
	Static Pressure (in. w.g.)	0.006	0.017	0.033	0.054	0.081	0.113	0.150	0.193	0.241	
1 Slot 12" Inlet	Sound (NC)	-	-	-	18	25	30	34	39	42	
	Throw (ft)	1-3-10	4-9-17	8-12-22	10-15-25	13-19-28	15-22-31	17-23-33	19-25-35	21-26-37	
	Flow Rate (cfm)	105	175	245	315	385	455	525	595	665	
1 Slot 12" Inlet	Total Pressure (in. w.g.)	0.007	0.019	0.038	0.063	0.094	0.131	0.174	0.224	0.280	
	Static Pressure (in. w.g.)	0.006	0.016	0.032	0.053	0.079	0.110	0.147	0.188	0.235	
	Sound (NC)	-	-	-	17	24	29	34	38	41	
1 Slot 12" Inlet	Throw (ft)	1-3-12	4-8-21	7-15-26	12-19-29	15-23-32	18-25-35	21-27-38	23-28-40	25-30-43	

For performance notes, see end of section

PERFORMANCE DATA

60" Length – 1 Slot AS with Engineered Plenum (CFP)

EF, CMF, FM, TG916, TZ, and Hybrid Frames

1.0" Slot Width	1 Slot 6" Inlet	Flow Rate (cfm)	75	105	135	165	195	225	255	285	315
		Total Pressure (in. w.g.)	0.025	0.048	0.080	0.119	0.167	0.222	0.285	0.356	0.435
	1 Slot 8" Inlet	Flow Rate (cfm)	75	115	155	195	235	275	315	355	395
		Total Pressure (in. w.g.)	0.016	0.038	0.069	0.109	0.159	0.217	0.285	0.362	0.448
	1 Slot 10" Oval Inlet	Flow Rate (cfm)	75	115	155	195	235	275	315	355	395
		Total Pressure (in. w.g.)	0.014	0.033	0.060	0.094	0.137	0.188	0.246	0.313	0.387
1.5" Slot Width	1 Slot 6" Inlet	Flow Rate (cfm)	90	120	150	180	210	240	270	300	330
		Total Pressure (in. w.g.)	0.031	0.056	0.087	0.125	0.171	0.223	0.282	0.349	0.422
	1 Slot 8" Inlet	Flow Rate (cfm)	90	130	170	210	250	290	330	370	410
		Total Pressure (in. w.g.)	0.019	0.040	0.069	0.105	0.148	0.200	0.258	0.325	0.399
	1 Slot 10" Oval Inlet	Flow Rate (cfm)	90	135	180	225	270	315	360	405	450
		Total Pressure (in. w.g.)	0.016	0.036	0.064	0.101	0.145	0.197	0.257	0.326	0.402
1.5" Slot Width	1 Slot 10" Inlet	Flow Rate (cfm)	90	135	180	225	270	315	360	405	450
		Total Pressure (in. w.g.)	0.014	0.032	0.056	0.088	0.127	0.173	0.226	0.286	0.353
	1 Slot 12" Oval Inlet	Flow Rate (cfm)	90	140	190	240	290	340	390	440	490
		Total Pressure (in. w.g.)	0.015	0.036	0.067	0.106	0.155	0.213	0.280	0.357	0.442
	1 Slot 12" Inlet	Flow Rate (cfm)	90	140	190	240	290	340	390	440	490
		Total Pressure (in. w.g.)	0.014	0.033	0.061	0.098	0.142	0.196	0.258	0.328	0.407

PERFORMANCE DATA

60" Length – 1 Slot AS with Engineered Plenum (CFP)

EF, CMF, FM, TG916, TZ, and Hybrid Frames

2.0" Slot Width	1 Slot 8" Inlet	Flow Rate (cfm)	105	155	205	255	305	355	405	455	505
		Total Pressure (in. w.g.)	0.017	0.036	0.063	0.098	0.140	0.189	0.246	0.311	0.383
		Static Pressure (in. w.g.)	0.011	0.024	0.042	0.064	0.092	0.125	0.162	0.205	0.252
	1 Slot 10" Oval Inlet	Sound (NC)	-	-	-	22	28	32	37	40	44
		Throw (ft)	1-3-10	3-6-15	5-10-19	7-12-24	10-14-26	11-17-28	13-19-30	14-21-31	16-23-33
		Flow Rate (cfm)	105	160	215	270	325	380	435	490	545
	1 Slot 10" Inlet	Total Pressure (in. w.g.)	0.012	0.029	0.052	0.082	0.119	0.162	0.213	0.270	0.334
		Static Pressure (in. w.g.)	0.010	0.023	0.041	0.065	0.094	0.128	0.168	0.213	0.264
		Sound (NC)	-	-	-	20	26	31	35	39	42
	1 Slot 12" Oval Inlet	Throw (ft)	1-3-10	3-6-15	5-10-20	8-13-24	10-15-27	12-18-29	14-20-31	15-23-33	17-24-34
		Flow Rate (cfm)	105	160	215	270	325	380	435	490	545
		Total Pressure (in. w.g.)	0.011	0.025	0.045	0.072	0.104	0.142	0.186	0.236	0.292
1 Slot 12" Inlet	Static Pressure (in. w.g.)	0.009	0.022	0.039	0.062	0.090	0.123	0.161	0.204	0.252	
	Sound (NC)	-	-	-	18	24	29	33	37	41	
	Throw (ft)	1-3-10	3-6-15	5-10-20	8-13-24	10-15-27	12-18-29	14-20-31	15-23-33	17-24-34	
1 Slot 12" Inlet	Flow Rate (cfm)	105	160	215	270	325	380	435	490	545	
	Total Pressure (in. w.g.)	0.010	0.024	0.043	0.068	0.099	0.135	0.177	0.225	0.278	
	Static Pressure (in. w.g.)	0.009	0.021	0.039	0.061	0.088	0.121	0.158	0.201	0.248	
2.5" Slot Width	1 Slot 10" Oval Inlet	Sound (NC)	-	-	-	22	28	33	37	41	45
		Throw (ft)	1-3-10	3-7-16	6-11-22	9-14-25	11-17-27	13-20-29	15-22-32	17-24-34	19-25-35
		Flow Rate (cfm)	120	190	260	330	400	470	540	610	680
	1 Slot 10" Inlet	Total Pressure (in. w.g.)	0.011	0.027	0.051	0.082	0.121	0.167	0.221	0.282	0.350
		Static Pressure (in. w.g.)	0.008	0.020	0.037	0.060	0.088	0.121	0.160	0.204	0.253
		Sound (NC)	-	-	-	21	27	32	37	41	44
	1 Slot 12" Oval Inlet	Throw (ft)	1-3-10	3-7-16	6-11-22	9-14-25	11-17-27	13-20-29	15-22-32	17-24-34	19-25-35
		Flow Rate (cfm)	120	190	260	330	400	470	540	610	680
		Total Pressure (in. w.g.)	0.009	0.024	0.044	0.071	0.105	0.144	0.191	0.243	0.302
	1 Slot 12" Inlet	Static Pressure (in. w.g.)	0.007	0.019	0.035	0.057	0.083	0.115	0.151	0.193	0.240
		Sound (NC)	-	-	-	19	25	30	35	39	42
		Throw (ft)	1-3-10	3-7-16	6-11-22	9-14-25	11-17-27	13-20-29	15-22-32	17-24-34	19-25-35
1 Slot 12" Inlet	Flow Rate (cfm)	120	190	260	330	400	470	540	610	680	
	Total Pressure (in. w.g.)	0.009	0.022	0.041	0.066	0.097	0.134	0.177	0.226	0.281	
	Static Pressure (in. w.g.)	0.007	0.018	0.034	0.055	0.081	0.112	0.148	0.189	0.234	
3.0" Slot Width	1 Slot 10" Oval Inlet	Sound (NC)	-	-	-	22	28	33	37	41	45
		Throw (ft)	1-3-10	3-7-16	5-11-21	9-14-24	11-16-26	13-19-28	15-21-30	17-23-32	19-24-34
		Flow Rate (cfm)	135	210	285	360	435	510	585	660	735
	1 Slot 10" Inlet	Total Pressure (in. w.g.)	0.011	0.026	0.048	0.077	0.113	0.155	0.203	0.259	0.321
		Static Pressure (in. w.g.)	0.007	0.017	0.031	0.050	0.073	0.100	0.132	0.168	0.208
		Sound (NC)	-	-	-	21	27	32	37	40	44
	1 Slot 12" Oval Inlet	Throw (ft)	1-3-10	3-7-16	5-11-21	9-14-24	11-16-26	13-19-28	15-21-30	17-23-32	19-24-34
		Flow Rate (cfm)	135	210	285	360	435	510	585	660	735
		Total Pressure (in. w.g.)	0.009	0.022	0.040	0.064	0.093	0.128	0.168	0.214	0.266
	1 Slot 12" Inlet	Static Pressure (in. w.g.)	0.007	0.016	0.029	0.046	0.068	0.093	0.123	0.156	0.193
		Sound (NC)	-	-	-	18	24	29	34	38	41
		Throw (ft)	1-3-10	3-7-16	5-11-21	9-14-24	11-16-26	13-19-28	15-21-30	17-23-32	19-24-34
1 Slot 12" Inlet	Flow Rate (cfm)	135	210	285	360	435	510	585	660	735	
	Total Pressure (in. w.g.)	0.008	0.020	0.036	0.058	0.085	0.116	0.153	0.195	0.242	
	Static Pressure (in. w.g.)	0.006	0.015	0.028	0.045	0.065	0.090	0.118	0.151	0.187	
1 Slot 12" Inlet	Sound (NC)	-	-	-	17	23	28	33	36	40	
	Throw (ft)	1-3-12	3-7-21	6-14-25	10-18-29	14-21-31	17-24-34	19-26-37	22-27-39	24-29-41	

For performance notes, see end of section

PERFORMANCE DATA

24" Length - 1 Slot AS with Engineered Plenum (CFP)

OFS Frame

1.0" Slot Width	1 Slot 6" Inlet	Flow Rate (cfm)	25	45	65	85	105	125	145	165	185
		Total Pressure (in. w.g.)	0.016	0.048	0.095	0.157	0.232	0.320	0.421	0.536	0.662
	1 Slot 8" Inlet	Flow Rate (cfm)	25	45	65	85	105	125	145	165	185
		Total Pressure (in. w.g.)	0.016	0.047	0.093	0.153	0.226	0.312	0.410	0.520	0.643
	1 Slot 10" Oval Inlet	Flow Rate (cfm)	25	45	65	85	105	125	145	165	185
		Total Pressure (in. w.g.)	0.016	0.047	0.093	0.152	0.225	0.310	0.408	0.517	0.638
1 Slot 12" Oval Inlet	Flow Rate (cfm)	25	45	65	85	105	125	145	165	185	
	Total Pressure (in. w.g.)	0.016	0.048	0.094	0.154	0.228	0.314	0.412	0.523	0.646	
1.5" Slot Width	1 Slot 6" Inlet	Flow Rate (cfm)	30	50	70	90	110	130	150	170	190
		Total Pressure (in. w.g.)	0.013	0.034	0.063	0.100	0.145	0.199	0.259	0.327	0.403
	1 Slot 8" Inlet	Flow Rate (cfm)	30	50	70	90	110	130	150	170	190
		Total Pressure (in. w.g.)	0.012	0.032	0.059	0.094	0.136	0.185	0.241	0.304	0.373
	1 Slot 10" Oval Inlet	Flow Rate (cfm)	30	50	70	90	110	130	150	170	190
		Total Pressure (in. w.g.)	0.012	0.031	0.058	0.092	0.132	0.180	0.234	0.295	0.362
1 Slot 12" Oval Inlet	Flow Rate (cfm)	30	50	70	90	110	130	150	170	190	
	Total Pressure (in. w.g.)	0.012	0.032	0.059	0.094	0.136	0.185	0.241	0.303	0.372	
1.5" Slot Width	1 Slot 6" Inlet	Flow Rate (cfm)	30	50	70	90	110	130	150	170	190
		Total Pressure (in. w.g.)	0.012	0.032	0.059	0.093	0.135	0.184	0.240	0.302	0.371
	1 Slot 8" Inlet	Flow Rate (cfm)	30	50	70	90	110	130	150	170	190
		Total Pressure (in. w.g.)	0.012	0.031	0.058	0.092	0.133	0.181	0.235	0.296	0.363
	1 Slot 10" Oval Inlet	Flow Rate (cfm)	30	50	70	90	110	130	150	170	190
		Total Pressure (in. w.g.)	0.012	0.031	0.058	0.092	0.133	0.181	0.235	0.296	0.363
1 Slot 12" Oval Inlet	Flow Rate (cfm)	30	50	70	90	110	130	150	170	190	
	Total Pressure (in. w.g.)	0.012	0.032	0.059	0.094	0.136	0.185	0.241	0.303	0.372	
1.5" Slot Width	1 Slot 6" Inlet	Flow Rate (cfm)	30	50	70	90	110	130	150	170	190
		Total Pressure (in. w.g.)	0.012	0.032	0.059	0.093	0.135	0.184	0.240	0.302	0.371
	1 Slot 8" Inlet	Flow Rate (cfm)	30	50	70	90	110	130	150	170	190
		Total Pressure (in. w.g.)	0.012	0.032	0.059	0.094	0.137	0.186	0.242	0.305	0.374
	1 Slot 10" Oval Inlet	Flow Rate (cfm)	30	50	70	90	110	130	150	170	190
		Total Pressure (in. w.g.)	0.012	0.032	0.059	0.094	0.135	0.184	0.240	0.302	0.370
1 Slot 12" Oval Inlet	Flow Rate (cfm)	30	50	70	90	110	130	150	170	190	
	Total Pressure (in. w.g.)	0.012	0.032	0.059	0.094	0.135	0.184	0.240	0.302	0.370	

PERFORMANCE DATA

24" Length - 1 Slot AS with Engineered Plenum (CFP)

OFS Frame

2.0" Slot Width	1 Slot 8" Inlet	Flow Rate (cfm)	35	65	95	125	155	185	215	245	275
		Total Pressure (in. w.g.)	0.008	0.026	0.052	0.086	0.128	0.178	0.235	0.300	0.371
		Static Pressure (in. w.g.)	0.007	0.023	0.047	0.078	0.116	0.160	0.212	0.269	0.333
	1 Slot 10" Oval Inlet	Sound (NC)	-	-	-	15	22	27	31	35	39
		Throw (ft)	1-3-10	4-9-21	8-15-27	13-20-31	17-24-34	20-26-37	23-28-40	25-30-43	26-32-46
		Flow Rate (cfm)	35	65	95	125	155	185	215	245	275
	1 Slot 10" Inlet	Total Pressure (in. w.g.)	0.008	0.025	0.050	0.083	0.124	0.172	0.227	0.289	0.357
		Static Pressure (in. w.g.)	0.008	0.024	0.048	0.080	0.118	0.164	0.216	0.275	0.340
		Sound (NC)	-	-	-	-	20	26	30	34	37
	1 Slot 12" Oval Inlet	Throw (ft)	1-3-10	4-9-21	8-15-27	13-20-31	17-24-34	20-26-37	23-28-40	25-30-43	26-32-46
		Flow Rate (cfm)	35	65	95	125	155	185	215	245	275
		Total Pressure (in. w.g.)	0.008	0.025	0.050	0.083	0.124	0.171	0.226	0.288	0.356
1 Slot 12" Inlet	Static Pressure (in. w.g.)	0.008	0.024	0.048	0.080	0.119	0.164	0.217	0.275	0.341	
	Sound (NC)	-	-	-	-	20	26	30	34	37	
	Throw (ft)	1-3-10	4-9-21	8-15-27	13-20-31	17-24-34	20-26-37	23-28-40	25-30-43	26-32-46	
1 Slot 12" Inlet	Flow Rate (cfm)	35	65	95	125	155	185	215	245	275	
	Total Pressure (in. w.g.)	0.008	0.025	0.050	0.083	0.123	0.171	0.225	0.287	0.355	
	Static Pressure (in. w.g.)	0.008	0.024	0.049	0.081	0.120	0.166	0.219	0.279	0.345	
2.5" Slot Width	1 Slot 10" Oval Inlet	Sound (NC)	-	-	-	-	20	25	30	34	37
		Throw (ft)	1-3-13	5-11-26	11-19-31	17-25-36	21-28-40	25-31-44	27-33-47	29-36-51	31-38-54
		Flow Rate (cfm)	45	85	125	165	205	245	285	325	365
	1 Slot 10" Inlet	Total Pressure (in. w.g.)	0.008	0.026	0.054	0.090	0.135	0.187	0.248	0.316	0.392
		Static Pressure (in. w.g.)	0.008	0.025	0.050	0.084	0.125	0.173	0.229	0.291	0.361
		Sound (NC)	-	-	-	17	23	29	33	37	41
	1 Slot 12" Oval Inlet	Throw (ft)	1-3-11	4-10-23	10-17-29	15-22-33	18-26-37	22-28-40	25-30-43	27-33-46	28-34-49
		Flow Rate (cfm)	45	85	125	165	205	245	285	325	365
		Total Pressure (in. w.g.)	0.008	0.026	0.053	0.089	0.134	0.186	0.247	0.314	0.390
	1 Slot 12" Inlet	Static Pressure (in. w.g.)	0.008	0.025	0.050	0.084	0.125	0.174	0.229	0.292	0.362
		Sound (NC)	-	-	-	16	23	28	32	36	40
		Throw (ft)	1-3-11	4-10-23	10-17-29	15-22-33	18-26-37	22-28-40	25-30-43	27-33-46	28-34-49
1 Slot 12" Inlet	Flow Rate (cfm)	45	85	125	165	205	245	285	325	365	
	Total Pressure (in. w.g.)	0.008	0.026	0.053	0.088	0.132	0.183	0.242	0.309	0.382	
	Static Pressure (in. w.g.)	0.008	0.025	0.051	0.086	0.128	0.177	0.234	0.298	0.369	
3.0" Slot Width	1 Slot 10" Oval Inlet	Sound (NC)	-	-	-	-	20	25	30	33	37
		Throw (ft)	2-4-15	4-10-23	10-17-29	15-22-33	18-26-37	22-28-40	25-30-43	27-33-46	28-34-49
		Flow Rate (cfm)	50	90	130	170	210	250	290	330	370
	1 Slot 10" Inlet	Total Pressure (in. w.g.)	0.007	0.021	0.042	0.068	0.101	0.140	0.184	0.234	0.289
		Static Pressure (in. w.g.)	0.006	0.019	0.038	0.062	0.091	0.125	0.164	0.209	0.257
		Sound (NC)	-	-	-	-	20	25	29	33	37
	1 Slot 12" Oval Inlet	Throw (ft)	1-2-9	3-8-21	7-15-27	12-20-31	16-24-34	19-26-37	22-28-40	25-30-43	26-32-45
		Flow Rate (cfm)	50	90	130	170	210	250	290	330	370
		Total Pressure (in. w.g.)	0.007	0.021	0.041	0.068	0.100	0.139	0.183	0.232	0.287
	1 Slot 12" Inlet	Static Pressure (in. w.g.)	0.007	0.019	0.038	0.062	0.091	0.125	0.165	0.209	0.258
		Sound (NC)	-	-	-	-	20	25	29	33	37
		Throw (ft)	1-2-9	3-8-21	7-15-27	12-20-31	16-24-34	19-26-37	22-28-40	25-30-43	26-32-45
1 Slot 12" Inlet	Flow Rate (cfm)	50	90	130	170	210	250	290	330	370	
	Total Pressure (in. w.g.)	0.007	0.020	0.040	0.066	0.098	0.135	0.178	0.226	0.280	
	Static Pressure (in. w.g.)	0.007	0.019	0.038	0.062	0.092	0.127	0.167	0.212	0.261	
1 Slot 12" Inlet	Sound (NC)	-	-	-	-	19	24	29	33	36	
	Throw (ft)	1-3-13	5-10-27	10-19-32	17-25-37	21-29-41	25-32-45	28-34-48	30-36-52	31-39-55	
	Flow Rate (cfm)	50	90	130	170	210	250	290	330	370	
1 Slot 12" Inlet	Total Pressure (in. w.g.)	0.007	0.020	0.040	0.066	0.097	0.134	0.177	0.224	0.277	
	Static Pressure (in. w.g.)	0.007	0.020	0.038	0.063	0.093	0.128	0.168	0.213	0.263	
	Sound (NC)	-	-	-	-	19	24	28	32	36	
1 Slot 12" Inlet	Throw (ft)	1-3-13	5-10-27	10-19-32	17-25-37	21-29-41	25-32-45	28-34-48	30-36-52	31-39-55	
	Flow Rate (cfm)	50	90	130	170	210	250	290	330	370	
	Total Pressure (in. w.g.)	0.007	0.020	0.040	0.066	0.097	0.134	0.177	0.224	0.277	
1 Slot 12" Inlet	Static Pressure (in. w.g.)	0.007	0.020	0.038	0.063	0.093	0.128	0.168	0.213	0.263	
	Sound (NC)	-	-	-	-	19	24	28	32	36	
	Throw (ft)	1-3-13	5-10-27	10-19-32	17-25-37	21-29-41	25-32-45	28-34-48	30-36-52	31-39-55	

PERFORMANCE DATA

48" Length - 1 Slot AS with Engineered Plenum (CFP)

OFS Frame

1.0" Slot Width	1 Slot 6" Inlet	Flow Rate (cfm)	60	85	110	135	160	185	210	235	260
		Total Pressure (in. w.g.)	0.025	0.047	0.077	0.113	0.155	0.204	0.259	0.320	0.387
	1 Slot 8" Inlet	Flow Rate (cfm)	60	95	130	165	200	235	270	305	340
		Total Pressure (in. w.g.)	0.021	0.049	0.089	0.138	0.197	0.266	0.344	0.431	0.528
	1 Slot 10" Oval Inlet	Flow Rate (cfm)	60	95	130	165	200	235	270	305	340
		Total Pressure (in. w.g.)	0.020	0.048	0.085	0.133	0.189	0.255	0.330	0.413	0.505
1.5" Slot Width	1 Slot 6" Inlet	Flow Rate (cfm)	70	100	130	160	190	220	250	280	310
		Total Pressure (in. w.g.)	0.021	0.042	0.069	0.103	0.143	0.189	0.241	0.299	0.363
	1 Slot 8" Inlet	Flow Rate (cfm)	70	115	160	205	250	295	340	385	430
		Total Pressure (in. w.g.)	0.016	0.041	0.076	0.121	0.176	0.239	0.312	0.394	0.485
	1 Slot 10" Oval Inlet	Flow Rate (cfm)	70	115	160	205	250	295	340	385	430
		Total Pressure (in. w.g.)	0.015	0.038	0.071	0.112	0.161	0.219	0.285	0.360	0.441
1.5" Slot Width	1 Slot 10" Inlet	Flow Rate (cfm)	70	115	160	205	250	295	340	385	430
		Total Pressure (in. w.g.)	0.014	0.035	0.065	0.102	0.147	0.200	0.259	0.326	0.399
	1 Slot 12" Oval Inlet	Flow Rate (cfm)	70	120	170	220	270	320	370	420	470
		Total Pressure (in. w.g.)	0.015	0.040	0.077	0.124	0.181	0.248	0.325	0.410	0.505
	1 Slot 12" Inlet	Flow Rate (cfm)	70	120	170	220	270	320	370	420	470
		Total Pressure (in. w.g.)	0.014	0.039	0.074	0.119	0.173	0.236	0.309	0.390	0.479

PERFORMANCE DATA

48" Length - 1 Slot AS with Engineered Plenum (CFP)

OFS Frame

2.0" Slot Width	1 Slot 8" Inlet	Flow Rate (cfm)	85	135	185	235	285	335	385	435	485
		Total Pressure (in. w.g.)	0.013	0.031	0.057	0.089	0.128	0.174	0.227	0.286	0.352
		Static Pressure (in. w.g.)	0.009	0.022	0.039	0.061	0.087	0.117	0.151	0.189	0.231
	1 Slot 10" Oval Inlet	Sound (NC)	-	-	-	22	28	33	37	41	44
		Throw (ft)	1-3-10	4-8-16	7-11-22	10-14-25	12-17-27	14-20-30	16-23-32	18-24-34	20-25-36
		Flow Rate (cfm)	85	145	205	265	325	385	445	505	565
	1 Slot 10" Inlet	Total Pressure (in. w.g.)	0.011	0.030	0.058	0.094	0.138	0.189	0.248	0.314	0.387
		Static Pressure (in. w.g.)	0.010	0.026	0.048	0.078	0.113	0.154	0.201	0.254	0.313
		Sound (NC)	-	-	-	21	27	32	36	40	43
	1 Slot 12" Oval Inlet	Throw (ft)	1-3-10	4-9-18	8-12-23	11-16-26	13-20-29	16-23-32	18-24-34	20-26-37	22-27-39
		Flow Rate (cfm)	85	145	205	265	325	385	445	505	565
		Total Pressure (in. w.g.)	0.011	0.030	0.057	0.093	0.135	0.186	0.244	0.308	0.380
1 Slot 12" Inlet	Static Pressure (in. w.g.)	0.010	0.026	0.049	0.078	0.113	0.155	0.202	0.255	0.313	
	Sound (NC)	-	-	-	20	27	32	36	40	43	
	Throw (ft)	1-3-10	4-9-18	8-12-23	11-16-26	13-20-29	16-23-32	18-24-34	20-26-37	22-27-39	
1 Slot 12" Inlet	Flow Rate (cfm)	85	145	205	265	325	385	445	505	565	
	Total Pressure (in. w.g.)	0.011	0.029	0.055	0.088	0.129	0.176	0.231	0.292	0.360	
	Static Pressure (in. w.g.)	0.010	0.026	0.049	0.079	0.115	0.157	0.204	0.258	0.317	
1 Slot 12" Inlet	Sound (NC)	-	-	-	19	25	30	35	38	42	
	Throw (ft)	1-3-10	4-9-18	8-12-23	11-16-26	13-20-29	16-23-32	18-24-34	20-26-37	22-27-39	
	Flow Rate (cfm)	85	145	205	265	325	385	445	505	565	
1 Slot 12" Inlet	Total Pressure (in. w.g.)	0.011	0.028	0.054	0.086	0.126	0.173	0.226	0.286	0.352	
	Static Pressure (in. w.g.)	0.010	0.026	0.049	0.079	0.115	0.158	0.206	0.260	0.319	
	Sound (NC)	-	-	-	19	25	30	34	38	41	
1 Slot 12" Inlet	Throw (ft)	2-5-15	6-13-25	12-18-30	16-24-34	19-27-38	23-29-41	26-31-45	27-34-47	29-35-50	
	Flow Rate (cfm)	95	160	225	290	355	420	485	550	615	
	Total Pressure (in. w.g.)	0.010	0.025	0.048	0.077	0.113	0.156	0.204	0.258	0.319	
1 Slot 10" Oval Inlet	Static Pressure (in. w.g.)	0.007	0.019	0.036	0.058	0.084	0.114	0.149	0.188	0.230	
	Sound (NC)	-	-	-	19	26	31	35	39	42	
	Throw (ft)	1-3-10	4-8-17	7-12-23	10-15-26	13-19-29	15-22-31	17-24-33	20-25-36	22-27-38	
1 Slot 10" Inlet	Flow Rate (cfm)	95	160	225	290	355	420	485	550	615	
	Total Pressure (in. w.g.)	0.009	0.025	0.047	0.076	0.111	0.152	0.199	0.252	0.311	
	Static Pressure (in. w.g.)	0.007	0.019	0.036	0.058	0.084	0.115	0.149	0.188	0.231	
1 Slot 12" Oval Inlet	Sound (NC)	-	-	-	19	25	30	34	38	42	
	Throw (ft)	1-3-10	4-8-17	7-12-23	10-15-26	13-19-29	15-22-31	17-24-33	20-25-36	22-27-38	
	Flow Rate (cfm)	95	160	225	290	355	420	485	550	615	
1 Slot 12" Inlet	Total Pressure (in. w.g.)	0.009	0.023	0.044	0.070	0.102	0.140	0.183	0.231	0.285	
	Static Pressure (in. w.g.)	0.008	0.020	0.037	0.059	0.085	0.116	0.151	0.190	0.234	
	Sound (NC)	-	-	-	17	23	28	33	36	40	
1 Slot 12" Inlet	Throw (ft)	1-3-10	4-8-17	7-12-23	10-15-26	13-19-29	15-22-31	17-24-33	20-25-36	22-27-38	
	Flow Rate (cfm)	95	160	225	290	355	420	485	550	615	
	Total Pressure (in. w.g.)	0.008	0.022	0.042	0.068	0.098	0.135	0.176	0.222	0.274	
1 Slot 12" Inlet	Static Pressure (in. w.g.)	0.008	0.020	0.037	0.059	0.086	0.117	0.152	0.192	0.236	
	Sound (NC)	-	-	-	16	22	27	32	35	39	
	Throw (ft)	2-4-15	5-12-25	11-18-30	15-23-34	19-27-38	22-29-41	25-31-44	27-33-47	29-35-50	
3.0" Slot Width	1 Slot 10" Oval Inlet	Flow Rate (cfm)	105	180	255	330	405	480	555	630	705
		Total Pressure (in. w.g.)	0.009	0.024	0.047	0.077	0.113	0.156	0.205	0.261	0.323
		Static Pressure (in. w.g.)	0.006	0.017	0.032	0.051	0.074	0.102	0.133	0.168	0.206
	1 Slot 10" Inlet	Sound (NC)	-	-	-	21	28	33	37	41	44
		Throw (ft)	1-2-10	3-7-17	6-12-23	10-16-26	13-19-28	15-22-31	18-24-33	20-25-35	22-26-37
		Flow Rate (cfm)	105	180	255	330	405	480	555	630	705
	1 Slot 12" Oval Inlet	Total Pressure (in. w.g.)	0.009	0.024	0.045	0.074	0.109	0.150	0.198	0.251	0.311
		Static Pressure (in. w.g.)	0.006	0.017	0.032	0.051	0.075	0.102	0.133	0.168	0.207
		Sound (NC)	-	-	-	20	27	32	36	40	43
	1 Slot 12" Inlet	Throw (ft)	1-2-10	3-7-17	6-12-23	10-16-26	13-19-28	15-22-31	18-24-33	20-25-35	22-26-37
		Flow Rate (cfm)	105	180	255	330	405	480	555	630	705
		Total Pressure (in. w.g.)	0.008	0.021	0.041	0.066	0.097	0.134	0.176	0.223	0.276
1 Slot 12" Inlet	Static Pressure (in. w.g.)	0.006	0.017	0.032	0.052	0.075	0.103	0.135	0.170	0.209	
	Sound (NC)	-	-	-	18	24	29	33	37	40	
	Throw (ft)	1-2-10	3-7-17	6-12-23	10-16-26	13-19-28	15-22-31	18-24-33	20-25-35	22-26-37	
1 Slot 12" Inlet	Flow Rate (cfm)	105	180	255	330	405	480	555	630	705	
	Total Pressure (in. w.g.)	0.007	0.020	0.039	0.063	0.093	0.127	0.167	0.212	0.261	
	Static Pressure (in. w.g.)	0.006	0.017	0.032	0.052	0.076	0.104	0.136	0.171	0.211	
1 Slot 12" Inlet	Sound (NC)	-	-	-	17	23	28	32	36	39	
	Throw (ft)	2-4-15	5-11-25	10-18-30	16-24-34	19-27-38	23-29-42	26-32-45	27-34-48	29-36-50	

PERFORMANCE DATA

24" Length – 2 Slot AS with Engineered Plenum (CFP)

1.0 in. Slot Width	2 Slot 8" Inlet	Flow Rate (cfm)	35	70	105	140	175	210	245	280	315
		Total Pressure (in. w.g.)	0.005	0.022	0.049	0.087	0.135	0.195	0.265	0.347	0.439
		Static Pressure (in. w.g.)	0.005	0.019	0.043	0.077	0.120	0.172	0.235	0.306	0.388
	2 Slot 10" Inlet	Sound (NC)	-	-	-	17	24	29	34	38	42
		Throw (ft)	1-3-12	6-12-21	12-17-25	15-21-29	19-23-33	21-25-36	22-27-39	24-29-42	25-31-44
		Flow Rate (cfm)	35	70	105	140	175	210	245	280	315
	2 Slot 12" Inlet	Total Pressure (in. w.g.)	0.005	0.019	0.042	0.075	0.118	0.169	0.230	0.301	0.381
		Static Pressure (in. w.g.)	0.004	0.018	0.040	0.071	0.111	0.160	0.218	0.284	0.360
		Sound (NC)	-	-	-	16	23	28	33	37	41
2 Slot 12" Inlet	Throw (ft)	1-3-12	6-12-21	12-17-25	15-21-29	19-23-33	21-25-36	22-27-39	24-29-42	25-31-44	
	Flow Rate (cfm)	35	70	105	140	175	210	245	280	315	
	Total Pressure (in. w.g.)	0.004	0.017	0.039	0.070	0.109	0.157	0.214	0.279	0.354	
1.5 in. Slot Width	2 Slot 8" Inlet	Static Pressure (in. w.g.)	0.004	0.017	0.038	0.068	0.106	0.153	0.208	0.271	0.344
		Sound (NC)	-	-	-	15	22	28	32	36	40
		Throw (ft)	1-3-12	6-12-21	12-17-25	15-21-29	19-23-33	21-25-36	22-27-39	24-29-42	25-31-44
	2 Slot 10" Inlet	Flow Rate (cfm)	45	80	115	150	185	220	255	290	325
		Total Pressure (in. w.g.)	0.007	0.023	0.048	0.081	0.123	0.174	0.234	0.303	0.380
		Static Pressure (in. w.g.)	0.006	0.020	0.041	0.069	0.106	0.149	0.201	0.260	0.326
	2 Slot 12" Inlet	Sound (NC)	-	-	-	16	23	28	32	36	40
		Throw (ft)	2-3-12	5-11-21	10-15-25	13-20-29	16-23-32	19-25-35	22-26-37	23-28-40	24-30-42
		Flow Rate (cfm)	45	85	125	165	205	245	285	325	365
2 Slot 12" Inlet	Total Pressure (in. w.g.)	0.006	0.022	0.048	0.083	0.129	0.184	0.249	0.323	0.408	
	Static Pressure (in. w.g.)	0.006	0.021	0.045	0.078	0.120	0.171	0.231	0.301	0.380	
	Sound (NC)	-	-	-	18	25	30	35	38	42	
2 Slot 12" Inlet	Throw (ft)	2-3-12	5-11-22	11-17-26	15-21-30	18-24-34	21-26-37	23-28-40	24-30-42	26-32-45	
	Flow Rate (cfm)	45	85	125	165	205	245	285	325	365	
	Total Pressure (in. w.g.)	0.006	0.020	0.044	0.076	0.118	0.169	0.228	0.297	0.374	
2.0 in. Slot Width	2 Slot 8" Inlet	Static Pressure (in. w.g.)	0.005	0.020	0.042	0.074	0.114	0.162	0.220	0.286	0.361
		Sound (NC)	-	-	-	17	24	29	34	38	41
		Throw (ft)	2-3-12	5-11-22	11-17-26	15-21-30	18-24-34	21-26-37	23-28-40	24-30-42	26-32-45
	2 Slot 10" Inlet	Flow Rate (cfm)	55	100	145	190	235	280	325	370	415
		Total Pressure (in. w.g.)	0.006	0.021	0.044	0.076	0.117	0.166	0.223	0.289	0.364
		Static Pressure (in. w.g.)	0.005	0.016	0.034	0.058	0.088	0.125	0.169	0.219	0.276
	2 Slot 12" Inlet	Sound (NC)	-	-	-	16	23	28	33	37	41
		Throw (ft)	2-4-12	5-11-22	11-16-26	14-21-30	17-24-34	20-26-37	23-28-40	24-30-42	26-32-45
		Flow Rate (cfm)	55	105	155	205	255	305	355	405	455
2 Slot 12" Inlet	Total Pressure (in. w.g.)	0.005	0.018	0.040	0.070	0.108	0.155	0.210	0.274	0.345	
	Static Pressure (in. w.g.)	0.004	0.016	0.035	0.061	0.095	0.136	0.184	0.239	0.302	
	Sound (NC)	-	-	-	16	23	28	33	37	41	
2 Slot 12" Inlet	Throw (ft)	2-4-12	6-12-23	11-17-27	15-22-31	19-25-35	22-27-38	24-29-41	26-31-44	27-33-47	
	Flow Rate (cfm)	55	105	155	205	255	305	355	405	455	
	Total Pressure (in. w.g.)	0.004	0.016	0.035	0.062	0.096	0.137	0.185	0.241	0.304	
2.5 in. Slot Width	2 Slot 10" Inlet	Static Pressure (in. w.g.)	0.004	0.015	0.033	0.057	0.089	0.127	0.172	0.224	0.283
		Sound (NC)	-	-	-	15	22	28	32	36	40
		Throw (ft)	2-4-12	6-12-23	11-17-27	15-22-31	19-25-35	22-27-38	24-29-41	26-31-44	27-33-47
	2 Slot 12" Inlet	Flow Rate (cfm)	65	125	185	245	305	365	425	485	545
		Total Pressure (in. w.g.)	0.005	0.017	0.038	0.067	0.103	0.148	0.201	0.261	0.330
		Static Pressure (in. w.g.)	0.004	0.014	0.031	0.054	0.084	0.120	0.163	0.212	0.268
	2 Slot 12" Inlet	Sound (NC)	-	-	-	16	23	29	33	38	41
		Throw (ft)	2-4-12	6-12-23	11-17-28	15-23-32	19-25-36	23-28-39	24-30-42	26-32-45	28-34-48
		Flow Rate (cfm)	65	130	195	260	325	390	455	520	585
2 Slot 12" Inlet	Total Pressure (in. w.g.)	0.004	0.016	0.036	0.064	0.099	0.143	0.195	0.254	0.322	
	Static Pressure (in. w.g.)	0.004	0.014	0.032	0.057	0.089	0.128	0.174	0.227	0.287	
	Sound (NC)	-	-	-	17	23	29	34	38	41	
2 Slot 12" Inlet	Throw (ft)	2-4-12	7-12-23	12-18-29	16-23-33	20-26-37	23-29-41	25-31-44	27-33-47	29-35-50	
	Flow Rate (cfm)	75	140	205	270	335	400	465	530	595	
	Total Pressure (in. w.g.)	0.005	0.016	0.035	0.060	0.093	0.133	0.179	0.233	0.294	
3.0 in. Slot Width	2 Slot 10" Inlet	Static Pressure (in. w.g.)	0.003	0.012	0.026	0.045	0.070	0.099	0.134	0.174	0.219
		Sound (NC)	-	-	-	15	22	28	33	37	40
		Throw (ft)	2-4-12	6-11-22	11-16-27	14-21-31	18-25-35	21-27-38	24-29-41	25-31-44	27-33-47
	2 Slot 12" Inlet	Flow Rate (cfm)	75	145	215	285	355	425	495	565	635
		Total Pressure (in. w.g.)	0.004	0.014	0.031	0.055	0.085	0.122	0.165	0.215	0.272
		Static Pressure (in. w.g.)	0.003	0.012	0.027	0.047	0.072	0.104	0.140	0.183	0.231
	2 Slot 12" Inlet	Sound (NC)	-	-	-	-	22	27	32	36	40
		Throw (ft)	2-4-12	6-11-23	11-17-28	15-23-32	19-26-36	22-28-40	25-30-43	26-32-46	28-34-48
		Flow Rate (cfm)	75	145	215	285	355	425	495	565	635
2 Slot 12" Inlet	Total Pressure (in. w.g.)	0.003	0.012	0.027	0.047	0.072	0.104	0.140	0.183	0.231	
	Sound (NC)	-	-	-	-	22	27	32	36	40	
	Throw (ft)	2-4-12	6-11-23	11-17-28	15-23-32	19-26-36	22-28-40	25-30-43	26-32-46	28-34-48	

For performance notes, see end of section

PERFORMANCE DATA

48" Length – 2 Slot AS with Engineered Plenum (CFP)

1.0 in. Slot Width	2 Slot 8" Inlet	Flow Rate (cfm)	75	130	185	240	295	350	405	460	515
		Total Pressure (in. w.g.)	0.008	0.026	0.052	0.087	0.131	0.185	0.248	0.320	0.401
		Static Pressure (in. w.g.)	0.006	0.017	0.034	0.058	0.087	0.122	0.164	0.211	0.265
	2 Slot 10" Inlet	Sound (NC)	-	-	-	19	26	31	36	40	43
		Throw (ft)	1-3-11	4-8-19	7-13-23	12-17-26	14-20-29	17-22-31	19-24-34	21-25-36	22-27-38
		Flow Rate (cfm)	75	135	195	255	315	375	435	495	555
2 Slot 12" Inlet	Total Pressure (in. w.g.)	0.006	0.020	0.042	0.073	0.111	0.157	0.211	0.274	0.344	
	Static Pressure (in. w.g.)	0.005	0.017	0.034	0.059	0.090	0.128	0.172	0.222	0.279	
	Sound (NC)	-	-	-	17	24	29	34	38	42	
2 Slot 12" Inlet	Throw (ft)	1-3-11	4-9-19	8-14-23	12-19-27	15-21-30	18-23-32	20-25-35	21-26-37	23-28-39	
	Flow Rate (cfm)	75	135	195	255	315	375	435	495	555	
	Total Pressure (in. w.g.)	0.005	0.017	0.036	0.061	0.094	0.133	0.179	0.232	0.291	
1.5 in. Slot Width	2 Slot 8" Inlet	Static Pressure (in. w.g.)	0.005	0.015	0.032	0.055	0.084	0.119	0.160	0.207	0.260
		Sound (NC)	-	-	-	16	23	28	32	36	40
		Throw (ft)	1-3-12	4-10-21	9-16-26	14-20-29	17-23-33	20-25-36	22-27-38	24-29-41	25-31-43
	2 Slot 10" Inlet	Flow Rate (cfm)	100	160	220	280	340	400	460	520	580
		Total Pressure (in. w.g.)	0.013	0.033	0.063	0.102	0.150	0.208	0.275	0.352	0.438
		Static Pressure (in. w.g.)	0.008	0.020	0.038	0.062	0.091	0.126	0.167	0.214	0.266
2 Slot 10" Inlet	Sound (NC)	-	-	-	22	28	33	38	42	45	
	Throw (ft)	1-3-11	3-7-18	6-12-23	10-15-26	13-19-28	15-22-31	17-23-33	19-25-35	21-26-37	
	Flow Rate (cfm)	100	165	230	295	360	425	490	555	620	
2 Slot 12" Inlet	Total Pressure (in. w.g.)	0.009	0.025	0.049	0.081	0.120	0.168	0.223	0.286	0.357	
	Static Pressure (in. w.g.)	0.007	0.020	0.038	0.063	0.093	0.130	0.172	0.221	0.276	
	Sound (NC)	-	-	-	19	26	31	36	40	43	
2 Slot 12" Inlet	Throw (ft)	1-3-11	3-8-18	7-13-23	11-16-26	13-20-29	16-22-31	18-24-34	20-25-36	22-27-38	
	Flow Rate (cfm)	100	165	230	295	360	425	490	555	620	
	Total Pressure (in. w.g.)	0.008	0.021	0.041	0.067	0.099	0.139	0.184	0.236	0.295	
2.0 in. Slot Width	2 Slot 8" Inlet	Static Pressure (in. w.g.)	0.007	0.018	0.035	0.058	0.086	0.120	0.160	0.205	0.256
		Sound (NC)	-	-	-	18	24	29	33	37	40
		Throw (ft)	1-3-12	4-9-20	7-14-25	12-18-29	15-22-32	17-24-35	20-26-37	22-28-40	24-30-42
	2 Slot 10" Inlet	Flow Rate (cfm)	130	200	270	340	410	480	550	620	690
		Total Pressure (in. w.g.)	0.015	0.036	0.066	0.105	0.153	0.210	0.276	0.351	0.434
		Static Pressure (in. w.g.)	0.007	0.016	0.029	0.046	0.067	0.092	0.121	0.154	0.190
2 Slot 10" Inlet	Sound (NC)	-	-	-	22	28	33	37	41	44	
	Throw (ft)	1-3-11	4-8-17	6-12-23	10-15-26	12-18-28	14-21-30	16-23-32	18-24-34	20-26-36	
	Flow Rate (cfm)	130	210	290	370	450	530	610	690	770	
2 Slot 12" Inlet	Total Pressure (in. w.g.)	0.010	0.026	0.049	0.080	0.118	0.164	0.217	0.278	0.346	
	Static Pressure (in. w.g.)	0.006	0.016	0.031	0.051	0.076	0.105	0.139	0.178	0.221	
	Sound (NC)	-	-	-	20	27	32	36	40	44	
2 Slot 12" Inlet	Throw (ft)	1-3-11	4-9-18	7-13-24	11-16-27	13-19-29	15-23-32	18-24-34	20-26-36	22-27-38	
	Flow Rate (cfm)	130	210	290	370	450	530	610	690	770	
	Total Pressure (in. w.g.)	0.008	0.020	0.038	0.061	0.090	0.125	0.166	0.212	0.264	
2.5 in. Slot Width	2 Slot 10" Inlet	Static Pressure (in. w.g.)	0.006	0.015	0.029	0.047	0.070	0.097	0.128	0.164	0.204
		Sound (NC)	-	-	-	17	23	29	33	37	41
		Throw (ft)	2-4-12	4-10-20	8-14-26	12-18-29	14-21-32	17-25-35	19-27-38	22-28-40	24-30-42
	2 Slot 12" Inlet	Flow Rate (cfm)	160	250	340	430	520	610	700	790	880
		Total Pressure (in. w.g.)	0.011	0.027	0.051	0.081	0.119	0.163	0.215	0.274	0.340
		Static Pressure (in. w.g.)	0.006	0.014	0.027	0.042	0.062	0.085	0.112	0.143	0.178
2 Slot 12" Inlet	Sound (NC)	-	-	-	21	27	32	36	40	44	
	Throw (ft)	2-4-11	4-9-17	8-12-23	10-15-26	12-18-28	14-21-31	16-23-33	18-25-35	20-26-37	
	Flow Rate (cfm)	160	250	340	430	520	610	700	790	880	
2 Slot 12" Inlet	Total Pressure (in. w.g.)	0.008	0.020	0.036	0.058	0.085	0.117	0.154	0.197	0.244	
	Static Pressure (in. w.g.)	0.005	0.013	0.025	0.040	0.058	0.080	0.105	0.134	0.166	
	Sound (NC)	-	-	-	17	23	29	33	37	40	
2 Slot 12" Inlet	Throw (ft)	2-4-12	5-9-19	8-13-25	11-16-28	13-20-31	15-23-34	18-26-36	20-27-38	22-29-41	
	Flow Rate (cfm)	205	310	415	520	625	730	835	940	1045	
	Total Pressure (in. w.g.)	0.015	0.035	0.063	0.098	0.142	0.194	0.254	0.322	0.398	
3.0 in. Slot Width	2 Slot 10" Inlet	Static Pressure (in. w.g.)	0.006	0.015	0.027	0.042	0.060	0.082	0.108	0.136	0.168
		Sound (NC)	-	-	-	16	23	29	34	38	42
		Throw (ft)	2-5-11	5-8-17	8-11-22	9-14-25	11-17-28	13-20-30	15-23-32	17-24-34	19-25-36
	2 Slot 12" Inlet	Flow Rate (cfm)	205	315	425	535	645	755	865	975	1085
		Total Pressure (in. w.g.)	0.010	0.025	0.045	0.071	0.103	0.141	0.185	0.236	0.292
		Static Pressure (in. w.g.)	0.006	0.015	0.026	0.042	0.061	0.084	0.110	0.139	0.173
2 Slot 12" Inlet	Sound (NC)	-	-	-	21	27	32	36	40	43	
	Throw (ft)	2-5-12	6-9-19	9-13-25	11-16-28	13-19-31	15-23-33	17-25-36	20-27-38	22-28-40	

For performance notes, see end of section

PERFORMANCE DATA

60" Length 2 Slot AS with Engineered Plenum (CFP)

1.0 in. Slot Width	2 Slot 8" Inlet	Flow Rate (cfm)	135	195	255	315	375	435	495	555	615
		Total Pressure (in. w.g.)	0.021	0.044	0.076	0.116	0.164	0.220	0.285	0.359	0.440
		Static Pressure (in. w.g.)	0.012	0.025	0.042	0.065	0.092	0.123	0.160	0.201	0.247
	2 Slot 10" Inlet	Sound (NC)	-	-	17	24	29	34	38	42	45
		Throw (ft)	1-3-10	2-5-21	4-9-24	6-14-27	9-20-29	12-22-31	15-24-33	19-25-35	22-26-37
		Flow Rate (cfm)	135	200	265	330	395	460	525	590	655
	2 Slot 12" Inlet	Total Pressure (in. w.g.)	0.015	0.032	0.057	0.088	0.126	0.170	0.222	0.280	0.345
		Static Pressure (in. w.g.)	0.011	0.024	0.042	0.065	0.093	0.126	0.164	0.207	0.255
		Sound (NC)	-	-	-	21	27	32	36	40	43
2 Slot 12" Inlet	Throw (ft)	1-3-10	2-6-21	4-10-24	7-15-27	10-21-30	13-23-32	17-24-34	21-26-37	22-27-38	
	Flow Rate (cfm)	135	200	265	330	395	460	525	590	655	
	Total Pressure (in. w.g.)	0.012	0.026	0.046	0.071	0.102	0.138	0.180	0.227	0.280	
1.5 in. Slot Width	2 Slot 8" Inlet	Static Pressure (in. w.g.)	0.010	0.022	0.039	0.060	0.086	0.116	0.152	0.192	0.236
		Sound (NC)	-	-	-	19	24	29	33	37	40
		Throw (ft)	1-3-12	3-7-26	5-12-29	8-18-33	12-25-36	16-27-39	20-29-41	25-31-44	27-33-46
	2 Slot 10" Inlet	Flow Rate (cfm)	175	235	295	355	415	475	535	595	655
		Total Pressure (in. w.g.)	0.031	0.057	0.089	0.129	0.176	0.231	0.293	0.363	0.439
		Static Pressure (in. w.g.)	0.016	0.028	0.045	0.065	0.088	0.116	0.147	0.181	0.220
	2 Slot 12" Inlet	Sound (NC)	-	-	19	25	30	35	38	42	45
		Throw (ft)	1-3-10	2-5-18	3-7-23	5-10-26	6-14-28	8-18-30	10-22-32	13-24-33	16-25-35
		Flow Rate (cfm)	175	240	305	370	435	500	565	630	695
2 Slot 12" Inlet	Total Pressure (in. w.g.)	0.021	0.039	0.063	0.093	0.129	0.170	0.217	0.270	0.329	
	Static Pressure (in. w.g.)	0.014	0.027	0.044	0.065	0.089	0.118	0.150	0.187	0.228	
	Sound (NC)	-	-	16	23	28	32	36	40	43	
2 Slot 12" Inlet	Throw (ft)	1-3-10	2-5-19	3-8-24	5-11-26	7-15-28	9-20-30	12-23-32	14-24-34	18-25-36	
	Flow Rate (cfm)	175	240	305	370	435	500	565	630	695	
	Total Pressure (in. w.g.)	0.016	0.031	0.050	0.073	0.102	0.134	0.171	0.213	0.259	
2.0 in. Slot Width	2 Slot 8" Inlet	Static Pressure (in. w.g.)	0.013	0.025	0.041	0.060	0.082	0.109	0.139	0.173	0.210
		Sound (NC)	-	-	-	20	25	29	33	37	40
		Throw (ft)	1-3-12	3-6-23	4-9-29	6-13-31	8-19-34	11-25-37	14-27-39	17-29-41	21-30-43
	2 Slot 10" Inlet	Flow Rate (cfm)	215	290	365	440	515	590	665	740	815
		Total Pressure (in. w.g.)	0.035	0.064	0.101	0.147	0.202	0.265	0.336	0.417	0.505
		Static Pressure (in. w.g.)	0.012	0.021	0.033	0.048	0.066	0.087	0.110	0.136	0.165
	2 Slot 12" Inlet	Sound (NC)	-	-	21	26	31	35	39	42	45
		Throw (ft)	1-3-10	2-5-19	3-7-23	5-11-26	7-15-28	9-19-30	11-22-31	14-23-33	17-25-35
		Flow Rate (cfm)	215	295	375	455	535	615	695	775	855
2 Slot 12" Inlet	Total Pressure (in. w.g.)	0.021	0.039	0.064	0.094	0.130	0.171	0.219	0.272	0.331	
	Static Pressure (in. w.g.)	0.011	0.021	0.034	0.050	0.070	0.092	0.117	0.146	0.178	
	Sound (NC)	-	-	17	23	28	33	37	40	43	
2 Slot 12" Inlet	Throw (ft)	1-3-10	2-5-19	4-8-24	5-12-26	7-16-28	9-20-30	12-23-32	15-24-34	18-25-36	
	Flow Rate (cfm)	215	295	375	455	535	615	695	775	855	
	Total Pressure (in. w.g.)	0.015	0.028	0.046	0.068	0.094	0.124	0.158	0.197	0.239	
2.5 in. Slot Width	2 Slot 10" Inlet	Static Pressure (in. w.g.)	0.010	0.020	0.032	0.047	0.065	0.086	0.109	0.136	0.165
		Sound (NC)	-	-	-	20	25	29	33	37	40
		Throw (ft)	1-3-12	3-6-23	4-9-28	6-14-31	9-19-34	11-24-36	14-27-39	18-29-41	22-30-43
	2 Slot 12" Inlet	Flow Rate (cfm)	245	340	435	530	625	720	815	910	1005
		Total Pressure (in. w.g.)	0.021	0.041	0.067	0.100	0.139	0.185	0.237	0.295	0.360
		Static Pressure (in. w.g.)	0.009	0.017	0.028	0.041	0.057	0.076	0.097	0.121	0.148
	2 Slot 12" Inlet	Sound (NC)	-	-	17	23	28	33	37	41	44
		Throw (ft)	1-3-10	2-5-17	4-8-22	5-12-25	7-16-27	10-18-29	12-21-31	15-23-33	17-24-34
		Flow Rate (cfm)	245	340	435	530	625	720	815	910	1005
2 Slot 12" Inlet	Total Pressure (in. w.g.)	0.014	0.028	0.046	0.068	0.094	0.125	0.160	0.200	0.244	
	Static Pressure (in. w.g.)	0.008	0.016	0.026	0.039	0.055	0.073	0.093	0.116	0.141	
	Sound (NC)	-	-	-	20	25	30	34	37	41	
2 Slot 12" Inlet	Throw (ft)	1-3-12	3-6-21	4-9-26	6-14-30	9-19-32	12-22-35	15-25-37	18-28-39	20-29-41	
	Flow Rate (cfm)	280	395	510	625	740	855	970	1085	1200	
	Total Pressure (in. w.g.)	0.024	0.048	0.079	0.119	0.167	0.223	0.287	0.359	0.440	
3.0 in. Slot Width	2 Slot 10" Inlet	Static Pressure (in. w.g.)	0.007	0.015	0.025	0.037	0.052	0.070	0.090	0.112	0.137
		Sound (NC)	-	-	19	26	31	35	39	42	45
		Throw (ft)	1-3-10	2-5-15	4-9-20	6-12-23	8-14-26	11-17-27	12-19-29	14-21-31	15-23-33
	2 Slot 12" Inlet	Flow Rate (cfm)	280	405	530	655	780	905	1030	1155	1280
		Total Pressure (in. w.g.)	0.015	0.032	0.055	0.084	0.119	0.161	0.208	0.262	0.321
		Static Pressure (in. w.g.)	0.007	0.016	0.027	0.041	0.058	0.078	0.101	0.127	0.156
	2 Slot 12" Inlet	Sound (NC)	-	-	16	23	29	34	38	41	45
		Throw (ft)	1-3-12	3-6-19	5-11-25	8-15-29	11-18-31	14-21-34	16-24-36	18-27-38	20-28-40

Performance Notes:

- Testing in accordance with ASHRAE Standard 70-2006 "Method of Testing for Rating the Performance of Air Outlets and Inlets."
- Data is based on Adjusta-slot complete with Price Engineered Plenums (insulated) as a composite assembly.
- Plenums not provided by Price may demonstrate performance variations from data published by Price. Price cannot guarantee performance if a factory engineered plenum is not provided.
- All pressures are in in. w.g.
- Throw values are measured in feet for terminal velocities of 150 fpm (minimum), 100 fpm (middle) and 50 fpm (maximum).
- Throw data is based on supply air and room air being at isothermal conditions.
- Throw values are based on 1-way air pattern. For 2-way pattern, throw is determined from the 1-slot data at 1/2 the specified air volume.
- NC values are based on a room absorption of 10 dB re 10⁻¹² watts and one diffuser.
- Blanks "-" indicate an NC level below 15.

PERFORMANCE DATA

CF4 – 24 in. x 24 in. Module (AS Supply)

Inlet Size	Total Flow Rate (cfm) Throw (ft)	75 1-1-5	100 1-2-9	125 2-3-11	150 2-5-14	175 3-7-16	200 4-9-18	225 5-10-20	250 6-11-22	275 7-12-23
6	Total Pressure (in. w.g.)	0.029	0.052	0.081	0.117	0.159	0.208	0.263	0.325	0.393
	Static Pressure (in. w.g.)	0.020	0.036	0.056	0.081	0.110	0.143	0.182	0.224	0.271
	Sound (NC)	-	19	25	30	34	38	41	44	47
8	Total Pressure (in. w.g.)	0.018	0.031	0.049	0.070	0.096	0.125	0.158	0.195	0.236
	Static Pressure (in. w.g.)	0.015	0.026	0.041	0.059	0.080	0.104	0.132	0.163	0.198
	Sound (NC)	-	-	19	24	28	32	35	38	41
10	Total Pressure (in. w.g.)	0.014	0.025	0.040	0.057	0.078	0.101	0.128	0.159	0.192
	Static Pressure (in. w.g.)	0.013	0.023	0.036	0.052	0.071	0.093	0.118	0.145	0.176
	Sound (NC)	-	-	17	22	26	30	33	36	39

Performance Notes:

1. Testing in accordance with ASHRAE Standard 70-2006 "Method of Testing for Rating the Performance of Air Outlets and Inlets."
2. All pressures are in in. w.g.
3. Throw values are measured in feet for terminal velocities of 150 fpm (minimum), 100 fpm (middle) and 50 fpm (maximum).
4. Throw data is based on supply air and room air being at isothermal conditions.
5. NC values are based on a room absorption of 10 dB re 10⁻¹² watts.
6. Blanks "-" indicate an NC level below 15.

PERFORMANCE DATA

JS with Pressurized Ceiling Plenum (Non-Ducted)

1.0 in. Slot Width	1 Slot	Flow Rate (cfm/ft) Static Pressure (in. w.g.) Sound (NC) Throw (ft)	25 0.01 - 2-5-12	40 0.03 - 5-10-20	55 0.05 - 9-14-26	70 0.08 - 12-17-29	85 0.11 15 14-21-32	100 0.16 20 17-24-34	115 0.21 24 19-26-37
	2 Slot	Flow Rate (cfm/ft) Static Pressure (in. w.g.) Sound (NC) Throw (ft)	50 0.01 - 3-8-20	75 0.03 - 8-15-27	100 0.05 - 13-20-32	125 0.07 - 17-25-35	150 0.10 20 20-27-39	175 0.13 24 24-30-42	200 0.17 28 26-32-45
1.5 in. Slot Width	1 Slot	Flow Rate (cfm/ft) Static Pressure (in. w.g.) Sound (NC) Throw (ft)	30 0.01 - 2-3-12	45 0.02 - 3-8-18	60 0.03 - 6-12-24	75 0.04 - 9-15-28	90 0.06 - 12-18-31	105 0.08 - 14-21-34	120 0.11 18 16-24-36
	2 Slot	Flow Rate (cfm/ft) Static Pressure (in. w.g.) Sound (NC) Throw (ft)	60 0.01 - 2-6-20	85 0.02 - 5-11-28	110 0.03 - 8-18-32	135 0.04 - 12-22-35	160 0.05 15 17-26-38	185 0.07 19 20-29-41	210 0.09 23 23-31-44
2.0 in. Slot Width	1 Slot	Flow Rate (cfm/ft) Static Pressure (in. w.g.) Sound (NC) Throw (ft)	30 0.00 - 1-2-8	50 0.01 - 3-6-17	70 0.02 - 5-11-24	90 0.04 - 8-15-30	110 0.05 - 12-19-33	130 0.08 16 15-22-36	150 0.10 20 17-25-39
	2 Slot	Flow Rate (cfm/ft) Static Pressure (in. w.g.) Sound (NC) Throw (ft)	60 0.00 - 2-3-14	95 0.01 - 4-9-26	130 0.02 - 7-16-33	165 0.03 - 11-23-38	200 0.05 17 17-28-41	235 0.07 21 22-32-45	270 0.09 25 25-34-48
2.5 in. Slot Width	1 Slot	Flow Rate (cfm/ft) Static Pressure (in. w.g.) Sound (NC) Throw (ft)	30 0.00 - 1-1-6	55 0.01 - 2-5-16	80 0.02 - 5-10-24	105 0.03 - 8-16-31	130 0.05 - 12-19-35	155 0.07 17 15-23-39	180 0.10 21 18-27-42
	2 Slot	Flow Rate (cfm/ft) Static Pressure (in. w.g.) Sound (NC) Throw (ft)	60 0.00 - 1-2-9	105 0.01 - 3-7-26	150 0.02 - 7-15-35	195 0.03 - 11-24-40	240 0.05 18 17-29-44	285 0.07 23 23-34-48	330 0.09 27 27-37-52
3.0 in. Slot Width	1 Slot	Flow Rate (cfm/ft) Static Pressure (in. w.g.) Sound (NC) Throw (ft)	30 0.00 - 0-1-4	60 0.01 - 2-4-16	90 0.02 - 4-10-24	120 0.03 - 8-16-32	150 0.05 - 12-20-37	180 0.07 18 16-24-41	210 0.09 23 19-28-44
	2 Slot	Flow Rate (cfm/ft) Static Pressure (in. w.g.) Sound (NC) Throw (ft)	60 0.00 - 1-2-7	120 0.01 - 3-7-27	180 0.02 - 7-16-37	240 0.03 15 12-27-43	300 0.05 21 19-33-48	360 0.08 26 27-37-53	420 0.10 31 31-40-57

Performance Notes:

1. Testing in accordance with ASHRAE Standard 70-2006 "Method of Testing for Rating the Performance of Air Outlets and Inlets."
2. Data is based on pressurized ceiling plenum application with no plenum effect for pressure or sound.
3. All pressures are in in. w.g.
4. Throw values are measured in feet for terminal velocities of 150 fpm (minimum), 100 fpm (middle) and 50 fpm (maximum).
5. Throw data is based on active sections 4 ft long. For other lengths refer to Table A.
6. Throw data is based on supply air and room air being at isothermal conditions.
7. Throw values are based on 1 way air pattern. For 2 way pattern, throw is determined from the 1-slot data at 1/2 the specified air volume.
8. NC values are based on a room absorption of 10 dB, re 10⁻¹² watts, for a 4 ft section. For other lengths refer to Table B.
9. For supply units used as a return add 3 NC.
10. Blanks "-" indicate an NC level below 15.

Table A. Throw Correction Multiplier for Length

Length, ft	2	4	8	12
Throw Correction	0.8	1.0	1.3	1.5

Table B. NC Correction for Length

Length, ft	2	4	6	8	10
Supply	-2	0	+2	+3	+5
Return	0	+3	+5	+6	+8

PERFORMANCE DATA

24" Length – 1 Slot JS with Engineered Plenum (CFP)

1.0" Slot Width	1 Slot 6" Inlet	Flow Rate (cfm)	25	60	95	130	165	200	235	270	305	
		Total Pressure (in. w.g.)	0.005	0.029	0.073	0.137	0.221	0.324	0.447	0.590	0.753	
	1 Slot 8" Inlet	Static Pressure (in. w.g.)	0.004	0.023	0.058	0.109	0.176	0.259	0.358	0.472	0.602	
		Sound (NC)	-	-	-	18	25	30	35	39	43	
	1.5" Slot Width	1 Slot 6" Inlet	Throw (ft)	0-1-4	3-6-11	6-9-18	8-12-21	10-16-24	13-19-27	15-20-29	17-22-31	19-23-33
			Flow Rate (cfm)	25	65	105	145	185	225	265	305	345
1 Slot 8" Inlet		Total Pressure (in. w.g.)	0.004	0.025	0.064	0.123	0.200	0.296	0.410	0.543	0.695	
		Static Pressure (in. w.g.)	0.003	0.023	0.059	0.112	0.182	0.270	0.374	0.496	0.634	
1.5" Slot Width		1 Slot 10" Oval Inlet	Sound (NC)	-	-	-	16	23	29	34	39	43
			Throw (ft)	0-1-4	3-6-12	7-10-19	9-14-23	12-17-26	14-20-28	17-22-31	19-23-33	20-25-35
	1 Slot 10" Inlet	Flow Rate (cfm)	25	70	115	160	205	250	295	340	385	
		Total Pressure (in. w.g.)	0.003	0.025	0.066	0.128	0.210	0.313	0.435	0.578	0.741	
	1.5" Slot Width	1 Slot 10" Inlet	Static Pressure (in. w.g.)	0.003	0.023	0.063	0.122	0.200	0.298	0.415	0.551	0.707
			Sound (NC)	-	-	-	17	24	30	35	40	44
1 Slot 12" Oval Inlet		Throw (ft)	0-1-4	3-7-13	7-11-20	10-15-24	13-19-27	16-21-30	19-23-32	20-24-35	21-26-37	
		Flow Rate (cfm)	25	70	115	160	205	250	295	340	385	
1.5" Slot Width		1 Slot 12" Inlet	Total Pressure (in. w.g.)	0.003	0.024	0.065	0.126	0.206	0.307	0.427	0.568	0.728
			Static Pressure (in. w.g.)	0.003	0.023	0.062	0.120	0.198	0.294	0.409	0.543	0.697
	1 Slot 12" Inlet	Sound (NC)	-	-	-	16	24	29	35	39	43	
		Throw (ft)	0-1-4	3-7-13	7-11-20	10-15-24	13-19-27	16-21-30	19-23-32	20-24-35	21-26-37	
	1.5" Slot Width	1 Slot 6" Inlet	Flow Rate (cfm)	25	70	115	160	205	250	295	340	385
			Total Pressure (in. w.g.)	0.003	0.023	0.061	0.118	0.193	0.287	0.400	0.531	0.681
1 Slot 8" Inlet		Static Pressure (in. w.g.)	0.003	0.022	0.059	0.114	0.187	0.279	0.388	0.516	0.661	
		Sound (NC)	-	-	-	15	22	28	34	38	42	
1.5" Slot Width		1 Slot 8" Inlet	Throw (ft)	0-1-4	3-7-13	7-11-20	10-15-24	13-19-27	16-21-30	19-23-32	20-24-35	21-26-37
			Flow Rate (cfm)	25	70	115	160	205	250	295	340	385
	1 Slot 10" Oval Inlet	Total Pressure (in. w.g.)	0.003	0.022	0.059	0.113	0.186	0.277	0.386	0.513	0.657	
		Static Pressure (in. w.g.)	0.003	0.021	0.057	0.111	0.182	0.271	0.377	0.501	0.642	
	1.5" Slot Width	1 Slot 10" Inlet	Sound (NC)	-	-	-	22	28	33	38	42	
			Throw (ft)	0-1-4	3-7-13	7-11-20	10-15-24	13-19-27	16-21-30	19-23-32	20-24-35	21-26-37
1 Slot 12" Inlet		Flow Rate (cfm)	40	85	130	175	220	265	310	355	400	
		Total Pressure (in. w.g.)	0.008	0.036	0.083	0.151	0.238	0.346	0.473	0.620	0.788	
1.5" Slot Width		1 Slot 12" Inlet	Static Pressure (in. w.g.)	0.005	0.024	0.056	0.101	0.160	0.232	0.317	0.416	0.528
			Sound (NC)	-	-	-	21	27	32	37	41	45
	1 Slot 6" Inlet	Throw (ft)	1-1-5	3-6-13	6-10-20	9-13-24	11-17-27	13-20-29	16-22-32	18-24-34	20-25-36	
		Flow Rate (cfm)	40	95	150	205	260	315	370	425	480	
	1.5" Slot Width	1 Slot 8" Inlet	Total Pressure (in. w.g.)	0.005	0.029	0.072	0.135	0.218	0.320	0.441	0.582	0.742
			Static Pressure (in. w.g.)	0.004	0.024	0.061	0.114	0.183	0.269	0.371	0.490	0.624
1 Slot 10" Oval Inlet		Sound (NC)	-	-	-	19	26	32	36	40	44	
		Throw (ft)	1-1-5	3-7-14	8-11-22	10-15-26	13-20-29	16-22-32	19-24-34	21-26-37	23-28-39	
1.5" Slot Width		1 Slot 10" Inlet	Flow Rate (cfm)	40	100	160	220	280	340	400	460	520
			Total Pressure (in. w.g.)	0.004	0.026	0.067	0.126	0.205	0.302	0.418	0.553	0.707
	1 Slot 12" Oval Inlet	Static Pressure (in. w.g.)	0.004	0.024	0.061	0.115	0.187	0.275	0.381	0.503	0.643	
		Sound (NC)	-	-	-	18	25	31	35	40	44	
	1.5" Slot Width	1 Slot 12" Inlet	Throw (ft)	1-1-5	4-8-15	8-12-23	11-17-27	14-21-30	17-23-33	20-25-36	22-27-38	24-29-41
			Flow Rate (cfm)	40	100	160	220	280	340	400	460	520
1 Slot 6" Inlet		Total Pressure (in. w.g.)	0.004	0.025	0.065	0.123	0.200	0.295	0.408	0.539	0.689	
		Static Pressure (in. w.g.)	0.004	0.023	0.060	0.113	0.183	0.270	0.374	0.495	0.633	
1.5" Slot Width		1 Slot 8" Inlet	Sound (NC)	-	-	-	18	25	30	35	39	43
			Throw (ft)	1-1-5	4-8-15	8-12-23	11-17-27	14-21-30	17-23-33	20-25-36	22-27-38	24-29-41
	1 Slot 10" Oval Inlet	Flow Rate (cfm)	40	105	170	235	300	365	430	495	560	
		Total Pressure (in. w.g.)	0.004	0.026	0.067	0.128	0.209	0.310	0.430	0.570	0.729	
	1.5" Slot Width	1 Slot 10" Inlet	Static Pressure (in. w.g.)	0.004	0.024	0.063	0.121	0.197	0.292	0.405	0.537	0.687
			Sound (NC)	-	-	-	18	25	31	36	40	44
1 Slot 12" Inlet		Throw (ft)	1-1-5	4-8-16	9-13-23	12-18-27	15-22-31	18-24-34	21-26-37	23-28-40	24-30-42	
		Flow Rate (cfm)	40	105	170	235	300	365	430	495	560	
1.5" Slot Width		1 Slot 12" Inlet	Total Pressure (in. w.g.)	0.004	0.024	0.064	0.122	0.199	0.295	0.409	0.542	0.694
			Static Pressure (in. w.g.)	0.003	0.023	0.061	0.117	0.190	0.281	0.390	0.517	0.662
	1 Slot 6" Inlet	Sound (NC)	-	-	-	17	24	30	35	40	44	
		Throw (ft)	1-1-5	4-8-16	9-13-23	12-18-27	15-22-31	18-24-34	21-26-37	23-28-40	24-30-42	

PERFORMANCE DATA

24" Length – 1 Slot JS with Engineered Plenum (CFP)

2.0" Slot Width	1 Slot 8" Inlet	Flow Rate (cfm)	50	115	180	245	310	375	440	505	570
		Total Pressure (in. w.g.)	0.005	0.029	0.071	0.132	0.211	0.309	0.426	0.561	0.714
		Static Pressure (in. w.g.)	0.004	0.022	0.055	0.101	0.162	0.237	0.327	0.430	0.548
	1 Slot 10" Oval Inlet	Flow Rate (cfm)	50	125	200	275	350	425	500	575	650
		Total Pressure (in. w.g.)	0.004	0.027	0.068	0.129	0.209	0.308	0.426	0.564	0.720
		Static Pressure (in. w.g.)	0.004	0.023	0.059	0.111	0.180	0.266	0.368	0.486	0.622
	1 Slot 10" Inlet	Flow Rate (cfm)	50	125	200	275	350	425	500	575	650
		Total Pressure (in. w.g.)	0.004	0.026	0.066	0.125	0.203	0.299	0.413	0.547	0.699
		Static Pressure (in. w.g.)	0.004	0.023	0.058	0.109	0.177	0.261	0.361	0.477	0.610
	1 Slot 12" Oval Inlet	Flow Rate (cfm)	50	130	210	290	370	450	530	610	690
Total Pressure (in. w.g.)		0.004	0.025	0.065	0.124	0.202	0.299	0.415	0.549	0.703	
Static Pressure (in. w.g.)		0.003	0.023	0.059	0.113	0.184	0.272	0.377	0.499	0.639	
1 Slot 12" Inlet	Flow Rate (cfm)	50	130	210	290	370	450	530	610	690	
	Total Pressure (in. w.g.)	0.003	0.023	0.061	0.117	0.190	0.281	0.390	0.516	0.660	
	Static Pressure (in. w.g.)	0.003	0.022	0.057	0.108	0.176	0.260	0.361	0.478	0.612	
2.5" Slot Width	1 Slot 10" Oval Inlet	Flow Rate (cfm)	60	145	230	315	400	485	570	655	740
		Total Pressure (in. w.g.)	0.005	0.026	0.066	0.124	0.200	0.294	0.407	0.537	0.685
		Static Pressure (in. w.g.)	0.004	0.021	0.054	0.101	0.163	0.239	0.331	0.437	0.557
	1 Slot 10" Inlet	Flow Rate (cfm)	60	145	230	315	400	485	570	655	740
		Total Pressure (in. w.g.)	0.004	0.025	0.064	0.120	0.193	0.284	0.393	0.518	0.662
		Static Pressure (in. w.g.)	0.004	0.021	0.053	0.099	0.160	0.235	0.324	0.428	0.547
	1 Slot 12" Oval Inlet	Flow Rate (cfm)	60	155	250	345	440	535	630	725	820
		Total Pressure (in. w.g.)	0.004	0.025	0.066	0.126	0.205	0.303	0.420	0.556	0.711
		Static Pressure (in. w.g.)	0.003	0.022	0.058	0.110	0.179	0.264	0.367	0.486	0.621
	1 Slot 12" Inlet	Flow Rate (cfm)	60	155	250	345	440	535	630	725	820
Total Pressure (in. w.g.)		0.004	0.024	0.061	0.117	0.190	0.281	0.390	0.517	0.661	
Static Pressure (in. w.g.)		0.003	0.021	0.055	0.105	0.171	0.252	0.350	0.463	0.593	
3.0" Slot Width	1 Slot 10" Oval Inlet	Flow Rate (cfm)	70	165	260	355	450	545	640	735	830
		Total Pressure (in. w.g.)	0.005	0.027	0.067	0.124	0.200	0.293	0.404	0.533	0.680
		Static Pressure (in. w.g.)	0.004	0.021	0.051	0.095	0.153	0.224	0.309	0.407	0.519
	1 Slot 10" Inlet	Flow Rate (cfm)	70	165	260	355	450	545	640	735	830
		Total Pressure (in. w.g.)	0.005	0.026	0.064	0.120	0.192	0.282	0.389	0.513	0.654
		Static Pressure (in. w.g.)	0.004	0.020	0.050	0.093	0.150	0.220	0.303	0.399	0.509
	1 Slot 12" Oval Inlet	Flow Rate (cfm)	70	170	270	370	470	570	670	770	870
		Total Pressure (in. w.g.)	0.004	0.024	0.060	0.112	0.181	0.265	0.367	0.484	0.618
		Static Pressure (in. w.g.)	0.003	0.020	0.050	0.094	0.151	0.222	0.307	0.405	0.517
	1 Slot 12" Inlet	Flow Rate (cfm)	70	170	270	370	470	570	670	770	870
Total Pressure (in. w.g.)		0.004	0.022	0.055	0.103	0.166	0.244	0.337	0.446	0.569	
Static Pressure (in. w.g.)		0.003	0.019	0.047	0.089	0.144	0.211	0.292	0.386	0.492	

For performance notes, see end of section

PERFORMANCE DATA

48" Length – 1 Slot JS with Engineered Plenum (CFP)

1.0" Slot Width	1 Slot 6" Inlet	Flow Rate (cfm)	50	100	150	200	250	300	350	400	450
		Total Pressure (in. w.g.)	0.008	0.034	0.076	0.135	0.211	0.304	0.414	0.541	0.685
	1 Slot 8" Inlet	Static Pressure (in. w.g.)	0.004	0.018	0.040	0.070	0.110	0.158	0.216	0.282	0.356
		Sound (NC)	-	-	-	20	26	31	36	40	43
		Throw (ft)	1-1-5	2-5-12	5-9-19	8-12-24	10-15-27	12-19-30	14-22-32	17-24-34	19-26-37
		Flow Rate (cfm)	50	120	190	260	330	400	470	540	610
1.0" Slot Width	1 Slot 10" Oval Inlet	Total Pressure (in. w.g.)	0.005	0.029	0.073	0.136	0.220	0.323	0.445	0.588	0.750
		Static Pressure (in. w.g.)	0.004	0.022	0.054	0.102	0.164	0.241	0.332	0.439	0.560
	1 Slot 10" Inlet	Sound (NC)	-	-	-	21	27	33	37	41	45
		Throw (ft)	1-1-5	3-7-15	7-12-24	11-16-28	14-20-31	17-24-34	19-26-37	22-28-40	25-30-43
		Flow Rate (cfm)	50	130	210	290	370	450	530	610	690
		Total Pressure (in. w.g.)	0.004	0.026	0.068	0.130	0.212	0.313	0.434	0.575	0.736
1.0" Slot Width	1 Slot 12" Oval Inlet	Static Pressure (in. w.g.)	0.003	0.022	0.058	0.110	0.180	0.266	0.369	0.488	0.625
		Sound (NC)	-	-	-	20	27	32	37	41	45
	1 Slot 12" Inlet	Throw (ft)	1-1-5	3-8-16	9-13-25	12-18-29	15-23-33	19-26-37	22-28-40	25-30-43	26-32-45
		Flow Rate (cfm)	50	135	220	305	390	475	560	645	730
		Total Pressure (in. w.g.)	0.003	0.024	0.064	0.124	0.202	0.300	0.417	0.553	0.708
		Static Pressure (in. w.g.)	0.003	0.022	0.058	0.111	0.182	0.270	0.375	0.497	0.637
1.5" Slot Width	1 Slot 6" Inlet	Sound (NC)	-	-	-	19	26	32	37	41	44
		Throw (ft)	1-1-5	4-8-17	9-14-26	13-19-30	16-24-34	20-27-38	23-29-41	25-31-44	27-33-47
	1 Slot 8" Inlet	Flow Rate (cfm)	50	135	220	305	390	475	560	645	730
		Total Pressure (in. w.g.)	0.003	0.023	0.060	0.116	0.189	0.281	0.390	0.518	0.663
		Static Pressure (in. w.g.)	0.003	0.021	0.055	0.106	0.174	0.258	0.359	0.476	0.609
		Sound (NC)	-	-	-	18	25	31	36	40	44
1.5" Slot Width	1 Slot 10" Oval Inlet	Throw (ft)	1-1-5	4-8-17	9-14-26	13-19-30	16-24-34	20-27-38	23-29-41	25-31-44	27-33-47
		Flow Rate (cfm)	75	130	185	240	295	350	405	460	515
	1 Slot 10" Inlet	Total Pressure (in. w.g.)	0.013	0.040	0.081	0.137	0.207	0.291	0.389	0.502	0.630
		Static Pressure (in. w.g.)	0.004	0.013	0.026	0.043	0.065	0.092	0.123	0.159	0.199
		Sound (NC)	-	-	-	20	26	31	35	40	43
		Throw (ft)	1-1-5	2-4-13	4-8-18	6-12-24	9-15-28	12-17-31	13-20-33	15-23-35	17-25-37
1.5" Slot Width	1 Slot 12" Oval Inlet	Flow Rate (cfm)	75	160	245	330	415	500	585	670	755
		Total Pressure (in. w.g.)	0.007	0.032	0.076	0.138	0.218	0.317	0.434	0.569	0.723
	1 Slot 12" Inlet	Static Pressure (in. w.g.)	0.004	0.019	0.045	0.082	0.130	0.189	0.259	0.340	0.431
		Sound (NC)	-	-	-	22	28	34	38	42	45
		Throw (ft)	1-1-5	3-6-16	6-12-24	11-16-30	14-21-33	17-25-37	19-28-40	22-30-42	25-32-45
		Flow Rate (cfm)	75	175	275	375	475	575	675	775	875
1.5" Slot Width	1 Slot 12" Oval Inlet	Total Pressure (in. w.g.)	0.005	0.028	0.069	0.127	0.204	0.300	0.413	0.544	0.694
		Static Pressure (in. w.g.)	0.004	0.021	0.051	0.095	0.152	0.222	0.306	0.404	0.515
	1 Slot 12" Inlet	Sound (NC)	-	-	-	21	28	33	38	42	45
		Throw (ft)	1-1-5	3-7-17	8-14-27	12-19-32	16-24-36	19-28-39	22-30-43	26-32-46	28-34-49
		Flow Rate (cfm)	75	175	275	375	475	575	675	775	875
		Total Pressure (in. w.g.)	0.004	0.027	0.066	0.122	0.196	0.287	0.396	0.522	0.666
1.5" Slot Width	1 Slot 12" Inlet	Static Pressure (in. w.g.)	0.004	0.020	0.050	0.093	0.149	0.218	0.300	0.396	0.505
		Sound (NC)	-	-	-	20	27	33	37	41	45
	1 Slot 12" Inlet	Throw (ft)	1-1-5	3-7-17	8-14-27	12-19-32	16-24-36	19-28-39	22-30-43	26-32-46	28-34-49
		Flow Rate (cfm)	75	175	275	375	475	575	675	775	875
		Total Pressure (in. w.g.)	0.004	0.023	0.056	0.105	0.168	0.246	0.339	0.447	0.569
		Static Pressure (in. w.g.)	0.003	0.019	0.046	0.086	0.138	0.202	0.278	0.366	0.467
1.5" Slot Width	1 Slot 12" Inlet	Sound (NC)	-	-	-	18	25	30	35	39	42
		Throw (ft)	1-1-5	3-7-17	8-14-27	12-19-32	16-24-36	19-28-39	22-30-43	26-32-46	28-34-49
	1 Slot 12" Inlet	Flow Rate (cfm)	75	175	275	375	475	575	675	775	875
		Total Pressure (in. w.g.)	0.004	0.021	0.052	0.096	0.154	0.225	0.311	0.409	0.522
		Static Pressure (in. w.g.)	0.003	0.018	0.044	0.082	0.131	0.192	0.264	0.349	0.444
		Sound (NC)	-	-	-	17	24	29	34	38	41
1.5" Slot Width	1 Slot 12" Inlet	Throw (ft)	1-1-5	3-7-17	8-14-27	12-19-32	16-24-36	19-28-39	22-30-43	26-32-46	28-34-49
		Flow Rate (cfm)	75	175	275	375	475	575	675	775	875
	1 Slot 12" Inlet	Total Pressure (in. w.g.)	0.004	0.021	0.052	0.096	0.154	0.225	0.311	0.409	0.522
		Static Pressure (in. w.g.)	0.003	0.018	0.044	0.082	0.131	0.192	0.264	0.349	0.444
		Sound (NC)	-	-	-	17	24	29	34	38	41
		Throw (ft)	1-1-5	3-7-17	8-14-27	12-19-32	16-24-36	19-28-39	22-30-43	26-32-46	28-34-49

PERFORMANCE DATA

48" Length – 1 Slot JS with Engineered Plenum (CFP)

2.0" Slot Width	1 Slot 8" Inlet	Flow Rate (cfm)	95	190	285	380	475	570	665	760	855
		Total Pressure (in. w.g.)	0.009	0.035	0.078	0.138	0.216	0.311	0.423	0.552	0.699
		Static Pressure (in. w.g.)	0.004	0.016	0.036	0.064	0.100	0.144	0.197	0.257	0.325
	1 Slot 10" Oval Inlet	Sound (NC)	-	-	-	22	29	34	38	42	45
		Throw (ft)	1-1-5	2-5-16	5-12-24	9-16-31	13-20-35	16-24-38	19-28-41	21-31-44	24-33-46
		Flow Rate (cfm)	95	200	305	410	515	620	725	830	935
	1 Slot 10" Inlet	Total Pressure (in. w.g.)	0.006	0.026	0.060	0.109	0.172	0.249	0.341	0.447	0.567
		Static Pressure (in. w.g.)	0.004	0.017	0.039	0.070	0.110	0.159	0.218	0.285	0.362
		Sound (NC)	-	-	-	20	26	31	36	40	43
	1 Slot 12" Inlet	Throw (ft)	1-1-5	3-6-17	6-13-26	11-17-32	14-22-36	17-26-40	20-30-43	23-32-46	26-34-49
		Flow Rate (cfm)	95	200	305	410	515	620	725	830	935
		Total Pressure (in. w.g.)	0.006	0.025	0.057	0.104	0.164	0.237	0.325	0.425	0.540
1 Slot 12" Oval Inlet	Static Pressure (in. w.g.)	0.004	0.016	0.038	0.069	0.108	0.157	0.214	0.281	0.356	
	Sound (NC)	-	-	-	19	25	31	35	39	42	
	Throw (ft)	1-1-5	3-6-17	6-13-26	11-17-32	14-22-36	17-26-40	20-30-43	23-32-46	26-34-49	
1 Slot 12" Inlet	Flow Rate (cfm)	95	200	305	410	515	620	725	830	935	
	Total Pressure (in. w.g.)	0.005	0.021	0.048	0.086	0.136	0.197	0.270	0.354	0.449	
	Static Pressure (in. w.g.)	0.003	0.015	0.035	0.064	0.101	0.146	0.199	0.261	0.331	
1 Slot 12" Oval Inlet	Sound (NC)	-	-	-	16	23	28	33	37	40	
	Throw (ft)	1-1-5	3-6-17	6-13-26	11-17-32	14-22-36	17-26-40	20-30-43	23-32-46	26-34-49	
	Flow Rate (cfm)	95	200	305	410	515	620	725	830	935	
1 Slot 12" Inlet	Total Pressure (in. w.g.)	0.004	0.018	0.043	0.078	0.123	0.178	0.243	0.318	0.404	
	Static Pressure (in. w.g.)	0.003	0.014	0.034	0.061	0.096	0.139	0.190	0.249	0.316	
	Sound (NC)	-	-	-	-	21	27	31	35	38	
1 Slot 10" Oval Inlet	Throw (ft)	1-1-5	3-6-17	6-13-26	11-17-32	14-22-36	17-26-40	20-30-43	23-32-46	26-34-49	
	Flow Rate (cfm)	115	225	335	445	555	665	775	885	995	
	Total Pressure (in. w.g.)	0.007	0.026	0.058	0.102	0.158	0.227	0.308	0.402	0.508	
1 Slot 10" Inlet	Static Pressure (in. w.g.)	0.004	0.014	0.031	0.055	0.086	0.123	0.168	0.219	0.276	
	Sound (NC)	-	-	-	19	25	30	35	39	42	
	Throw (ft)	1-1-5	2-5-17	5-11-25	9-17-33	14-21-36	16-25-40	19-29-43	22-33-46	25-35-49	
1 Slot 12" Oval Inlet	Flow Rate (cfm)	115	225	335	445	555	665	775	885	995	
	Total Pressure (in. w.g.)	0.005	0.020	0.044	0.078	0.122	0.175	0.237	0.309	0.391	
	Static Pressure (in. w.g.)	0.003	0.013	0.029	0.052	0.080	0.115	0.157	0.204	0.258	
1 Slot 12" Inlet	Sound (NC)	-	-	-	16	22	27	31	35	39	
	Throw (ft)	1-1-5	2-5-17	5-11-25	9-17-33	14-21-36	16-25-40	19-29-43	22-33-46	25-35-49	
	Flow Rate (cfm)	115	225	335	445	555	665	775	885	995	
1 Slot 12" Inlet	Total Pressure (in. w.g.)	0.005	0.018	0.039	0.069	0.108	0.155	0.211	0.275	0.347	
	Static Pressure (in. w.g.)	0.003	0.013	0.028	0.049	0.077	0.110	0.150	0.195	0.247	
	Sound (NC)	-	-	-	-	20	25	30	34	37	
1 Slot 10" Oval Inlet	Throw (ft)	1-1-5	2-5-17	5-11-25	9-17-33	14-21-36	16-25-40	19-29-43	22-33-46	25-35-49	
	Flow Rate (cfm)	135	250	365	480	595	710	825	940	1055	
	Total Pressure (in. w.g.)	0.008	0.027	0.058	0.099	0.153	0.218	0.294	0.382	0.481	
1 Slot 10" Inlet	Static Pressure (in. w.g.)	0.004	0.012	0.026	0.046	0.070	0.100	0.135	0.175	0.220	
	Sound (NC)	-	-	-	19	25	30	34	38	41	
	Throw (ft)	1-1-5	2-5-17	4-10-24	7-16-32	11-20-37	16-24-40	18-28-44	21-31-46	24-35-49	
1 Slot 12" Oval Inlet	Flow Rate (cfm)	135	250	365	480	595	710	825	940	1055	
	Total Pressure (in. w.g.)	0.007	0.025	0.054	0.094	0.144	0.205	0.277	0.360	0.453	
	Static Pressure (in. w.g.)	0.004	0.012	0.026	0.045	0.070	0.099	0.134	0.174	0.219	
1 Slot 12" Inlet	Sound (NC)	-	-	-	18	24	29	34	37	41	
	Throw (ft)	1-1-5	2-5-17	4-10-24	7-16-32	11-20-37	16-24-40	18-28-44	21-31-46	24-35-49	
	Flow Rate (cfm)	135	250	365	480	595	710	825	940	1055	
1 Slot 12" Inlet	Total Pressure (in. w.g.)	0.006	0.020	0.043	0.075	0.115	0.163	0.221	0.286	0.361	
	Static Pressure (in. w.g.)	0.003	0.012	0.025	0.044	0.067	0.096	0.129	0.168	0.212	
	Sound (NC)	-	-	-	15	22	27	31	35	38	
1 Slot 12" Inlet	Throw (ft)	1-1-5	2-5-17	4-10-24	7-16-32	11-20-37	16-24-40	18-28-44	21-31-46	24-35-49	
	Flow Rate (cfm)	135	250	365	480	595	710	825	940	1055	
	Total Pressure (in. w.g.)	0.005	0.018	0.038	0.066	0.101	0.143	0.194	0.251	0.317	
1 Slot 12" Inlet	Static Pressure (in. w.g.)	0.003	0.011	0.024	0.042	0.065	0.092	0.125	0.162	0.204	
	Sound (NC)	-	-	-	-	20	25	29	33	36	
	Throw (ft)	1-1-5	2-5-17	4-10-24	7-16-32	11-20-37	16-24-40	18-28-44	21-31-46	24-35-49	

For performance notes, see end of section

PERFORMANCE DATA

60" Length – 1 Slot JS with Engineered Plenum (CFP)

1.0" Slot Width	1 Slot 6" Inlet	Flow Rate (cfm)	65	120	175	230	285	340	395	450	505
		Total Pressure (in. w.g.)	0.012	0.039	0.083	0.144	0.221	0.315	0.425	0.552	0.695
	1 Slot 8" Inlet	Static Pressure (in. w.g.)	0.005	0.016	0.034	0.058	0.090	0.128	0.172	0.223	0.281
		Sound (NC)	-	-	-	21	27	32	37	40	44
	1 Slot 10" Oval Inlet	Throw (ft)	1-1-5	2-5-13	4-10-19	7-13-25	10-16-28	12-19-31	14-22-33	16-25-36	18-27-38
		Flow Rate (cfm)	65	140	215	290	365	440	515	590	665
1 Slot 10" Inlet	Total Pressure (in. w.g.)	0.006	0.030	0.070	0.128	0.203	0.295	0.404	0.531	0.674	
	Static Pressure (in. w.g.)	0.004	0.020	0.047	0.085	0.135	0.196	0.269	0.353	0.448	
1 Slot 12" Oval Inlet	Sound (NC)	-	-	-	20	27	32	37	41	44	
	Throw (ft)	1-1-5	3-6-15	6-12-24	11-16-29	13-20-32	16-24-35	19-27-38	22-29-41	24-31-43	
1 Slot 12" Inlet	Flow Rate (cfm)	65	155	245	335	425	515	605	695	785	
	Total Pressure (in. w.g.)	0.005	0.027	0.067	0.126	0.203	0.298	0.411	0.542	0.692	
1 Slot 12" Inlet	Static Pressure (in. w.g.)	0.004	0.021	0.053	0.100	0.161	0.236	0.325	0.429	0.548	
	Sound (NC)	-	-	-	20	27	33	37	41	45	
1 Slot 12" Inlet	Throw (ft)	1-1-5	3-8-17	8-13-26	12-18-31	15-23-35	19-27-38	22-29-41	25-31-44	27-33-47	
	Flow Rate (cfm)	65	165	265	365	465	565	665	765	865	
1 Slot 12" Inlet	Total Pressure (in. w.g.)	0.004	0.026	0.065	0.121	0.195	0.287	0.396	0.522	0.666	
	Static Pressure (in. w.g.)	0.003	0.022	0.057	0.107	0.174	0.257	0.356	0.472	0.603	
1.5" Slot Width	1 Slot 6" Inlet	Sound (NC)	-	-	-	20	27	33	37	41	44
		Throw (ft)	1-1-5	4-9-18	10-14-27	13-20-32	17-25-36	21-28-40	24-31-43	27-33-46	28-35-49
1 Slot 8" Inlet	Flow Rate (cfm)	90	150	210	270	330	390	450	510	570	
	Total Pressure (in. w.g.)	0.016	0.045	0.088	0.146	0.218	0.304	0.405	0.520	0.649	
1 Slot 10" Oval Inlet	Static Pressure (in. w.g.)	0.003	0.008	0.017	0.027	0.041	0.057	0.076	0.098	0.122	
	Sound (NC)	-	-	16	23	28	33	38	42	45	
1 Slot 10" Inlet	Throw (ft)	1-1-5	2-4-13	3-7-18	5-12-24	8-14-29	11-17-32	13-20-34	15-22-36	17-25-38	
	Flow Rate (cfm)	90	180	270	360	450	540	630	720	810	
1 Slot 12" Oval Inlet	Total Pressure (in. w.g.)	0.008	0.032	0.073	0.130	0.203	0.292	0.398	0.520	0.658	
	Static Pressure (in. w.g.)	0.004	0.016	0.036	0.064	0.099	0.143	0.195	0.255	0.322	
1 Slot 12" Inlet	Sound (NC)	-	-	-	21	28	33	37	41	45	
	Throw (ft)	1-1-5	2-5-16	5-12-24	9-16-30	13-20-34	16-24-37	18-28-40	21-30-43	24-32-46	
1 Slot 12" Inlet	Flow Rate (cfm)	90	195	300	405	510	615	720	825	930	
	Total Pressure (in. w.g.)	0.006	0.026	0.062	0.113	0.178	0.260	0.356	0.467	0.594	
1 Slot 12" Inlet	Static Pressure (in. w.g.)	0.004	0.017	0.041	0.074	0.118	0.171	0.234	0.308	0.391	
	Sound (NC)	-	-	-	20	26	32	36	40	44	
1 Slot 12" Inlet	Throw (ft)	1-1-5	3-6-17	6-13-26	12-18-32	15-22-36	18-27-40	21-30-43	24-33-46	27-35-49	
	Flow Rate (cfm)	90	195	300	405	510	615	720	825	930	
1 Slot 12" Inlet	Total Pressure (in. w.g.)	0.004	0.021	0.049	0.090	0.142	0.207	0.283	0.372	0.473	
	Static Pressure (in. w.g.)	0.003	0.016	0.037	0.068	0.107	0.156	0.214	0.281	0.357	
1 Slot 12" Inlet	Sound (NC)	-	-	-	17	23	29	33	37	41	
	Throw (ft)	1-1-5	3-6-17	6-13-26	12-18-32	15-22-36	18-27-40	21-30-43	24-33-46	27-35-49	
1 Slot 12" Inlet	Flow Rate (cfm)	90	195	300	405	510	615	720	825	930	
	Total Pressure (in. w.g.)	0.004	0.019	0.044	0.081	0.129	0.187	0.256	0.336	0.427	
1 Slot 12" Inlet	Static Pressure (in. w.g.)	0.003	0.015	0.035	0.064	0.102	0.149	0.204	0.267	0.340	
	Sound (NC)	-	-	-	15	22	27	32	36	39	
1 Slot 12" Inlet	Throw (ft)	1-1-5	3-6-17	6-13-26	12-18-32	15-22-36	18-27-40	21-30-43	24-33-46	27-35-49	

PERFORMANCE DATA

60" Length – 1 Slot JS with Engineered Plenum (CFP)

2.0" Slot Width	1 Slot 8" Inlet	Flow Rate (cfm)	115	215	315	415	515	615	715	815	915
		Total Pressure (in. w.g.)	0.010	0.036	0.077	0.134	0.207	0.295	0.399	0.519	0.654
		Static Pressure (in. w.g.)	0.004	0.012	0.027	0.046	0.071	0.102	0.137	0.179	0.225
	1 Slot 10" Oval Inlet	Flow Rate (cfm)	115	225	335	445	555	665	775	885	995
		Total Pressure (in. w.g.)	0.007	0.026	0.057	0.100	0.156	0.224	0.304	0.397	0.502
		Static Pressure (in. w.g.)	0.004	0.014	0.031	0.054	0.084	0.121	0.164	0.213	0.270
	1 Slot 10" Inlet	Flow Rate (cfm)	115	225	335	445	555	665	775	885	995
		Total Pressure (in. w.g.)	0.006	0.024	0.054	0.095	0.148	0.212	0.288	0.376	0.475
		Static Pressure (in. w.g.)	0.004	0.014	0.030	0.053	0.083	0.119	0.162	0.211	0.267
	1 Slot 12" Oval Inlet	Flow Rate (cfm)	115	225	335	445	555	665	775	885	995
		Total Pressure (in. w.g.)	0.005	0.020	0.044	0.077	0.120	0.172	0.234	0.305	0.385
		Static Pressure (in. w.g.)	0.003	0.013	0.029	0.050	0.079	0.113	0.153	0.200	0.252
1 Slot 12" Inlet	Flow Rate (cfm)	115	225	335	445	555	665	775	885	995	
	Total Pressure (in. w.g.)	0.005	0.017	0.039	0.068	0.106	0.153	0.207	0.270	0.342	
	Static Pressure (in. w.g.)	0.003	0.012	0.027	0.048	0.075	0.108	0.147	0.191	0.242	
2.5" Slot Width	1 Slot 10" Oval Inlet	Flow Rate (cfm)	140	255	370	485	600	715	830	945	1060
		Total Pressure (in. w.g.)	0.008	0.027	0.056	0.097	0.148	0.210	0.283	0.367	0.462
		Static Pressure (in. w.g.)	0.003	0.012	0.024	0.042	0.064	0.091	0.122	0.158	0.199
	1 Slot 10" Inlet	Flow Rate (cfm)	140	255	370	485	600	715	830	945	1060
		Total Pressure (in. w.g.)	0.008	0.025	0.053	0.091	0.139	0.198	0.267	0.346	0.435
		Static Pressure (in. w.g.)	0.003	0.012	0.024	0.042	0.064	0.091	0.122	0.158	0.199
	1 Slot 12" Oval Inlet	Flow Rate (cfm)	140	255	370	485	600	715	830	945	1060
		Total Pressure (in. w.g.)	0.006	0.020	0.042	0.072	0.110	0.157	0.211	0.274	0.345
		Static Pressure (in. w.g.)	0.003	0.011	0.024	0.041	0.062	0.088	0.119	0.154	0.194
	1 Slot 12" Inlet	Flow Rate (cfm)	140	255	370	485	600	715	830	945	1060
		Total Pressure (in. w.g.)	0.005	0.017	0.037	0.063	0.097	0.137	0.185	0.239	0.301
		Static Pressure (in. w.g.)	0.003	0.011	0.023	0.039	0.060	0.085	0.115	0.149	0.188
3.0" Slot Width	1 Slot 10" Oval Inlet	Flow Rate (cfm)	165	285	405	525	645	765	885	1005	1125
		Total Pressure (in. w.g.)	0.010	0.029	0.058	0.097	0.147	0.207	0.276	0.357	0.447
		Static Pressure (in. w.g.)	0.003	0.010	0.019	0.033	0.049	0.070	0.093	0.120	0.150
	1 Slot 10" Inlet	Flow Rate (cfm)	165	285	405	525	645	765	885	1005	1125
		Total Pressure (in. w.g.)	0.009	0.027	0.054	0.091	0.138	0.194	0.259	0.334	0.419
		Static Pressure (in. w.g.)	0.003	0.010	0.020	0.033	0.050	0.071	0.095	0.122	0.153
	1 Slot 12" Oval Inlet	Flow Rate (cfm)	165	285	405	525	645	765	885	1005	1125
		Total Pressure (in. w.g.)	0.007	0.021	0.042	0.071	0.107	0.150	0.201	0.260	0.325
		Static Pressure (in. w.g.)	0.003	0.010	0.020	0.034	0.051	0.072	0.096	0.124	0.156
	1 Slot 12" Inlet	Flow Rate (cfm)	165	285	405	525	645	765	885	1005	1125
		Total Pressure (in. w.g.)	0.006	0.018	0.036	0.061	0.092	0.130	0.174	0.224	0.281
		Static Pressure (in. w.g.)	0.003	0.010	0.020	0.033	0.050	0.071	0.095	0.122	0.153

For performance notes, see end of section

PERFORMANCE DATA

24" Length – 2 Slot JS with Engineered Plenum (CFP)

1.0 in. Slot Width	2 Slot 8" Inlet	Flow Rate (cfm)	45	115	185	255	325	395	465	535	605
		Total Pressure (in. w.g.)	0.004	0.024	0.062	0.117	0.191	0.282	0.391	0.517	0.661
		Static Pressure (in. w.g.)	0.003	0.017	0.044	0.084	0.137	0.202	0.280	0.370	0.474
	2 Slot 10" Inlet	Sound (NC)	-	-	-	18	25	31	36	40	44
		Throw (ft)	1-1-5	4-9-18	10-14-24	13-20-28	17-22-31	20-24-34	22-26-37	23-28-40	25-30-43
		Flow Rate (cfm)	45	125	205	285	365	445	525	605	685
2 Slot 12" Inlet	Total Pressure (in. w.g.)	0.003	0.022	0.060	0.115	0.189	0.281	0.391	0.519	0.665	
	Static Pressure (in. w.g.)	0.002	0.019	0.051	0.098	0.161	0.239	0.333	0.442	0.567	
	Sound (NC)	-	-	-	18	25	31	36	40	44	
1.5 in. Slot Width	2 Slot 8" Inlet	Throw (ft)	1-1-5	5-10-19	11-16-25	15-21-29	19-23-33	21-26-36	23-28-40	25-30-43	26-32-45
		Flow Rate (cfm)	60	145	230	315	400	485	570	655	740
		Total Pressure (in. w.g.)	0.004	0.025	0.063	0.117	0.189	0.278	0.384	0.507	0.647
	2 Slot 10" Inlet	Static Pressure (in. w.g.)	0.002	0.014	0.035	0.067	0.107	0.158	0.218	0.288	0.367
		Sound (NC)	-	-	-	19	26	32	36	40	44
		Throw (ft)	1-1-5	3-7-18	8-14-25	13-19-29	16-23-33	20-26-36	23-28-39	24-30-42	26-32-45
2 Slot 12" Inlet	Flow Rate (cfm)	60	165	270	375	480	585	690	795	900	
	Total Pressure (in. w.g.)	0.003	0.021	0.057	0.110	0.180	0.267	0.371	0.493	0.632	
	Static Pressure (in. w.g.)	0.002	0.016	0.042	0.080	0.131	0.195	0.271	0.360	0.462	
2.0 in. Slot Width	2 Slot 8" Inlet	Sound (NC)	-	-	-	19	26	32	36	40	44
		Throw (ft)	1-1-5	4-9-20	11-17-27	15-23-32	20-26-36	23-28-40	25-31-43	27-33-46	29-35-49
		Flow Rate (cfm)	80	175	270	365	460	555	650	745	840
	2 Slot 10" Inlet	Total Pressure (in. w.g.)	0.006	0.030	0.071	0.129	0.205	0.299	0.410	0.538	0.684
		Static Pressure (in. w.g.)	0.003	0.014	0.033	0.061	0.097	0.141	0.193	0.254	0.323
		Sound (NC)	-	-	-	21	28	33	38	42	45
2 Slot 12" Inlet	Throw (ft)	1-1-5	3-6-18	7-14-26	12-19-30	16-24-34	19-27-38	23-29-41	25-31-44	27-33-46	
	Flow Rate (cfm)	80	190	300	410	520	630	740	850	960	
	Total Pressure (in. w.g.)	0.004	0.020	0.050	0.094	0.151	0.222	0.307	0.405	0.516	
2.5 in. Slot Width	2 Slot 8" Inlet	Static Pressure (in. w.g.)	0.002	0.013	0.032	0.059	0.095	0.139	0.192	0.253	0.323
		Sound (NC)	-	-	-	17	24	30	34	38	42
		Throw (ft)	1-1-5	3-7-20	8-16-28	14-22-32	18-26-36	22-28-40	25-31-43	27-33-47	29-35-49
	2 Slot 10" Inlet	Flow Rate (cfm)	80	190	300	410	520	630	740	850	960
		Total Pressure (in. w.g.)	0.003	0.015	0.037	0.070	0.113	0.165	0.228	0.301	0.384
		Static Pressure (in. w.g.)	0.002	0.011	0.028	0.053	0.085	0.125	0.173	0.228	0.291
2 Slot 12" Inlet	Sound (NC)	-	-	-	20	26	30	34	38	41	
	Throw (ft)	1-1-5	3-7-20	8-16-28	14-22-32	18-26-36	22-28-40	25-31-43	27-33-47	29-35-49	
	Flow Rate (cfm)	95	205	315	425	535	645	755	865	975	
3.0 in. Slot Width	2 Slot 8" Inlet	Total Pressure (in. w.g.)	0.004	0.019	0.046	0.083	0.132	0.191	0.262	0.344	0.437
		Static Pressure (in. w.g.)	0.002	0.011	0.025	0.045	0.072	0.104	0.143	0.187	0.238
		Sound (NC)	-	-	-	16	23	28	33	36	40
	2 Slot 10" Inlet	Throw (ft)	1-1-5	3-6-19	6-14-28	11-20-32	17-25-36	20-28-39	23-30-43	26-32-46	28-34-49
		Flow Rate (cfm)	95	205	315	425	535	645	755	865	975
		Total Pressure (in. w.g.)	0.003	0.013	0.031	0.057	0.090	0.131	0.179	0.235	0.299
2 Slot 12" Inlet	Static Pressure (in. w.g.)	0.002	0.009	0.021	0.039	0.061	0.089	0.122	0.160	0.203	
	Sound (NC)	-	-	-	-	18	23	28	31	35	
	Throw (ft)	1-1-5	3-6-19	6-14-28	11-20-32	17-25-36	20-28-39	23-30-43	26-32-46	28-34-49	
3.0 in. Slot Width	2 Slot 8" Inlet	Flow Rate (cfm)	115	230	345	460	575	690	805	920	1035
		Total Pressure (in. w.g.)	0.005	0.022	0.048	0.086	0.134	0.194	0.264	0.344	0.436
		Static Pressure (in. w.g.)	0.003	0.010	0.023	0.042	0.065	0.094	0.128	0.167	0.211
	2 Slot 10" Inlet	Sound (NC)	-	-	-	17	23	29	33	37	40
		Throw (ft)	1-1-5	2-5-19	5-12-28	10-19-33	15-24-36	19-28-40	22-31-43	26-33-46	28-35-49
		Flow Rate (cfm)	115	235	355	475	595	715	835	955	1075
2 Slot 12" Inlet	Total Pressure (in. w.g.)	0.003	0.014	0.033	0.059	0.092	0.133	0.181	0.237	0.300	
	Static Pressure (in. w.g.)	0.002	0.009	0.020	0.036	0.056	0.081	0.110	0.144	0.183	
	Sound (NC)	-	-	-	-	18	24	28	32	35	
2 Slot 12" Inlet	Throw (ft)	1-1-5	3-6-20	6-13-29	10-20-33	16-25-37	20-29-41	23-31-44	27-33-47	29-35-50	

For performance notes, see end of section

PERFORMANCE DATA

48" Length – 2 Slot JS with Engineered Plenum (CFP)

1.0 in. Slot Width	2 Slot 8" Inlet	Flow Rate (cfm)	85	180	275	370	465	560	655	750	845
		Total Pressure (in. w.g.)	0.007	0.030	0.071	0.128	0.202	0.293	0.401	0.526	0.667
		Static Pressure (in. w.g.)	0.003	0.014	0.032	0.058	0.091	0.133	0.181	0.238	0.302
	2 Slot 10" Inlet	Sound (NC)	-	-	-	21	28	33	38	41	45
		Throw (ft)	1-1-5	3-6-18	6-14-26	11-19-30	16-24-34	19-27-37	22-29-41	25-31-43	27-33-46
		Flow Rate (cfm)	85	195	305	415	525	635	745	855	965
2 Slot 12" Inlet	Total Pressure (in. w.g.)	0.004	0.020	0.049	0.090	0.144	0.211	0.291	0.383	0.488	
	Static Pressure (in. w.g.)	0.002	0.012	0.029	0.054	0.087	0.127	0.174	0.230	0.293	
	Sound (NC)	-	-	-	17	24	29	34	38	41	
2 Slot 12" Inlet	Throw (ft)	1-1-5	3-7-20	8-15-28	14-21-32	18-26-36	22-28-40	25-31-43	27-33-46	28-35-49	
	Flow Rate (cfm)	85	195	305	415	525	635	745	855	965	
	Total Pressure (in. w.g.)	0.003	0.014	0.035	0.065	0.105	0.153	0.211	0.278	0.354	
2 Slot 12" Inlet	Static Pressure (in. w.g.)	0.002	0.011	0.026	0.048	0.077	0.112	0.155	0.204	0.260	
	Sound (NC)	-	-	-	-	19	25	29	33	37	
	Throw (ft)	1-1-5	3-7-20	8-15-28	14-21-32	18-26-36	22-28-40	25-31-43	27-33-46	28-35-49	
1.5 in. Slot Width	2 Slot 8" Inlet	Flow Rate (cfm)	120	215	310	405	500	595	690	785	880
		Total Pressure (in. w.g.)	0.012	0.037	0.078	0.133	0.202	0.286	0.385	0.498	0.626
		Static Pressure (in. w.g.)	0.004	0.014	0.028	0.049	0.074	0.105	0.141	0.183	0.230
	2 Slot 10" Inlet	Sound (NC)	-	-	-	22	28	33	37	41	44
		Throw (ft)	1-1-5	2-4-17	4-9-25	7-16-30	11-20-34	15-24-37	19-28-40	21-30-42	24-32-45
		Flow Rate (cfm)	120	235	350	465	580	695	810	925	1040
2 Slot 10" Inlet	Total Pressure (in. w.g.)	0.006	0.022	0.048	0.085	0.132	0.189	0.257	0.335	0.423	
	Static Pressure (in. w.g.)	0.003	0.010	0.022	0.039	0.061	0.088	0.119	0.155	0.196	
	Sound (NC)	-	-	-	17	23	28	33	36	40	
2 Slot 12" Inlet	Throw (ft)	1-1-5	2-5-19	5-12-28	9-19-33	14-24-36	19-28-40	22-30-43	25-33-46	28-34-49	
	Flow Rate (cfm)	120	240	360	480	600	720	840	960	1080	
	Total Pressure (in. w.g.)	0.004	0.014	0.032	0.056	0.088	0.126	0.172	0.224	0.284	
2 Slot 12" Inlet	Static Pressure (in. w.g.)	0.002	0.008	0.018	0.033	0.051	0.074	0.100	0.131	0.166	
	Sound (NC)	-	-	-	-	18	23	28	31	35	
	Throw (ft)	1-1-5	2-5-19	5-12-29	10-19-33	15-24-37	19-29-41	23-31-44	26-33-47	29-35-50	
2.0 in. Slot Width	2 Slot 8" Inlet	Flow Rate (cfm)	150	240	330	420	510	600	690	780	870
		Total Pressure (in. w.g.)	0.017	0.044	0.083	0.135	0.199	0.276	0.365	0.466	0.580
		Static Pressure (in. w.g.)	0.006	0.015	0.028	0.045	0.066	0.092	0.121	0.155	0.193
	2 Slot 10" Inlet	Sound (NC)	-	-	16	23	28	33	37	41	44
		Throw (ft)	1-1-5	1-3-13	3-6-23	5-10-29	7-15-33	9-21-36	12-24-38	16-27-41	20-30-43
		Flow Rate (cfm)	150	270	390	510	630	750	870	990	1110
2 Slot 10" Inlet	Total Pressure (in. w.g.)	0.008	0.025	0.053	0.090	0.138	0.195	0.262	0.340	0.427	
	Static Pressure (in. w.g.)	0.003	0.010	0.021	0.036	0.054	0.077	0.103	0.134	0.168	
	Sound (NC)	-	-	-	18	24	29	33	37	40	
2 Slot 12" Inlet	Throw (ft)	1-1-5	2-4-17	4-9-27	7-15-33	10-22-37	15-26-40	20-30-43	23-33-46	26-34-49	
	Flow Rate (cfm)	150	280	410	540	670	800	930	1060	1190	
	Total Pressure (in. w.g.)	0.004	0.015	0.033	0.057	0.088	0.126	0.170	0.221	0.279	
2 Slot 12" Inlet	Static Pressure (in. w.g.)	0.002	0.008	0.016	0.028	0.043	0.061	0.083	0.108	0.136	
	Sound (NC)	-	-	-	-	19	24	28	32	35	
	Throw (ft)	1-1-5	2-5-18	4-10-28	8-17-34	12-23-38	16-28-41	21-32-45	24-34-48	27-36-50	
2.5 in. Slot Width	2 Slot 10" Inlet	Flow Rate (cfm)	185	310	435	560	685	810	935	1060	1185
		Total Pressure (in. w.g.)	0.011	0.031	0.062	0.102	0.153	0.214	0.286	0.367	0.459
		Static Pressure (in. w.g.)	0.004	0.011	0.022	0.037	0.055	0.077	0.102	0.131	0.164
	2 Slot 12" Inlet	Sound (NC)	-	-	-	20	26	31	35	38	42
		Throw (ft)	1-1-5	2-4-15	3-8-27	6-13-34	8-19-37	12-25-41	16-29-44	20-32-46	24-35-49
		Flow Rate (cfm)	185	315	445	575	705	835	965	1095	1225
2 Slot 12" Inlet	Total Pressure (in. w.g.)	0.006	0.017	0.035	0.058	0.087	0.123	0.164	0.211	0.264	
	Static Pressure (in. w.g.)	0.003	0.007	0.015	0.025	0.037	0.052	0.070	0.090	0.112	
	Sound (NC)	-	-	-	-	19	24	28	31	35	
2 Slot 12" Inlet	Throw (ft)	1-1-5	2-4-16	4-8-27	6-13-34	9-20-38	12-25-41	17-29-44	21-33-47	25-35-50	
	Flow Rate (cfm)	215	345	475	605	735	865	995	1125	1255	
	Total Pressure (in. w.g.)	0.015	0.038	0.071	0.116	0.171	0.237	0.313	0.400	0.498	
3.0 in. Slot Width	2 Slot 10" Inlet	Static Pressure (in. w.g.)	0.005	0.013	0.024	0.039	0.057	0.080	0.105	0.135	0.167
		Sound (NC)	-	-	15	22	28	32	36	40	43
		Throw (ft)	1-1-5	2-3-14	3-7-26	5-11-33	7-16-38	10-22-41	13-27-44	16-31-47	20-35-49
	2 Slot 12" Inlet	Flow Rate (cfm)	215	345	475	605	735	865	995	1125	1255
		Total Pressure (in. w.g.)	0.008	0.020	0.037	0.060	0.089	0.123	0.163	0.209	0.260
		Static Pressure (in. w.g.)	0.003	0.008	0.014	0.023	0.034	0.048	0.063	0.081	0.100
2 Slot 12" Inlet	Sound (NC)	-	-	-	-	19	24	28	31	35	
	Throw (ft)	1-1-5	2-3-14	3-7-26	5-11-33	7-16-38	10-22-41	13-27-44	16-31-47	20-35-49	

For performance notes, see end of section

PERFORMANCE DATA

60" Length – 2 Slot JS with Engineered Plenum (CFP)

1.0 in. Slot Width	2 Slot 8" Inlet	Flow Rate (cfm)	100	195	290	385	480	575	670	765	860
		Total Pressure (in. w.g.)	0.008	0.032	0.071	0.126	0.195	0.280	0.381	0.496	0.627
		Static Pressure (in. w.g.)	0.003	0.013	0.028	0.050	0.077	0.111	0.151	0.197	0.249
	2 Slot 10" Inlet	Sound (NC)	-	-	-	21	28	33	37	41	44
		Throw (ft)	1-1-5	2-5-18	5-11-26	8-17-30	13-22-34	17-26-37	20-28-40	23-30-43	26-32-45
		Flow Rate (cfm)	100	215	330	445	560	675	790	905	1020
	2 Slot 12" Inlet	Total Pressure (in. w.g.)	0.004	0.020	0.047	0.086	0.136	0.198	0.271	0.355	0.451
		Static Pressure (in. w.g.)	0.002	0.010	0.024	0.044	0.070	0.102	0.140	0.183	0.233
		Sound (NC)	-	-	-	17	23	29	33	37	40
2 Slot 12" Inlet	Throw (ft)	1-1-5	3-6-19	6-14-28	11-20-33	17-25-37	20-28-40	24-31-43	27-33-46	28-35-49	
	Flow Rate (cfm)	100	215	330	445	560	675	790	905	1020	
	Total Pressure (in. w.g.)	0.003	0.013	0.031	0.057	0.090	0.131	0.179	0.235	0.299	
1.5 in. Slot Width	2 Slot 8" Inlet	Static Pressure (in. w.g.)	0.002	0.009	0.020	0.037	0.058	0.085	0.116	0.152	0.193
		Sound (NC)	-	-	-	-	18	23	28	32	35
		Throw (ft)	1-1-5	3-6-19	6-14-28	11-20-33	17-25-37	20-28-40	24-31-43	27-33-46	28-35-49
	2 Slot 10" Inlet	Flow Rate (cfm)	145	240	335	430	525	620	715	810	905
		Total Pressure (in. w.g.)	0.016	0.044	0.087	0.143	0.213	0.297	0.395	0.507	0.633
		Static Pressure (in. w.g.)	0.005	0.015	0.029	0.048	0.072	0.100	0.133	0.171	0.213
	2 Slot 12" Inlet	Sound (NC)	-	-	16	24	29	34	38	42	45
		Throw (ft)	1-1-5	2-4-15	3-7-24	5-12-31	8-18-34	11-22-37	15-26-39	19-29-42	22-31-44
		Flow Rate (cfm)	145	265	385	505	625	745	865	985	1105
2 Slot 12" Inlet	Total Pressure (in. w.g.)	0.007	0.025	0.052	0.090	0.138	0.196	0.264	0.342	0.431	
	Static Pressure (in. w.g.)	0.003	0.010	0.021	0.036	0.056	0.079	0.107	0.139	0.174	
	Sound (NC)	-	-	-	18	24	29	33	37	40	
2 Slot 12" Inlet	Throw (ft)	1-1-5	2-5-18	4-10-28	7-17-33	11-22-37	16-27-40	21-31-43	24-33-46	26-35-49	
	Flow Rate (cfm)	145	275	405	535	665	795	925	1055	1185	
	Total Pressure (in. w.g.)	0.004	0.015	0.033	0.058	0.090	0.129	0.174	0.226	0.286	
2.0 in. Slot Width	2 Slot 8" Inlet	Static Pressure (in. w.g.)	0.002	0.008	0.017	0.029	0.045	0.065	0.087	0.114	0.144
		Sound (NC)	-	-	-	-	19	24	28	32	35
		Throw (ft)	1-1-5	2-5-20	5-11-29	8-19-34	13-24-38	18-29-42	22-32-45	25-34-48	28-36-51
	2 Slot 10" Inlet	Flow Rate (cfm)	185	275	365	455	545	635	725	815	905
		Total Pressure (in. w.g.)	0.026	0.057	0.100	0.155	0.222	0.302	0.393	0.497	0.613
		Static Pressure (in. w.g.)	0.008	0.018	0.031	0.049	0.070	0.095	0.124	0.157	0.193
	2 Slot 12" Inlet	Sound (NC)	-	-	19	25	30	35	38	42	45
		Throw (ft)	1-1-5	1-3-12	2-5-21	4-8-28	5-12-33	7-16-36	9-21-38	12-25-41	15-28-43
		Flow Rate (cfm)	185	310	435	560	685	810	935	1060	1185
2 Slot 12" Inlet	Total Pressure (in. w.g.)	0.011	0.031	0.062	0.102	0.153	0.214	0.285	0.366	0.457	
	Static Pressure (in. w.g.)	0.004	0.011	0.022	0.036	0.054	0.076	0.101	0.130	0.163	
	Sound (NC)	-	-	-	20	26	31	35	38	42	
2 Slot 12" Inlet	Throw (ft)	1-1-5	2-4-15	3-8-27	6-13-34	8-19-37	12-25-41	16-29-44	20-32-46	24-35-49	
	Flow Rate (cfm)	185	320	455	590	725	860	995	1130	1265	
	Total Pressure (in. w.g.)	0.006	0.018	0.036	0.061	0.092	0.129	0.173	0.224	0.280	
2.5 in. Slot Width	2 Slot 10" Inlet	Static Pressure (in. w.g.)	0.003	0.008	0.015	0.026	0.039	0.055	0.073	0.094	0.118
		Sound (NC)	-	-	-	-	19	24	29	32	35
		Throw (ft)	1-1-5	2-4-16	4-8-28	6-14-35	9-21-38	13-26-42	18-30-45	23-34-48	26-36-51
	2 Slot 12" Inlet	Flow Rate (cfm)	220	350	480	610	740	870	1000	1130	1260
		Total Pressure (in. w.g.)	0.015	0.038	0.072	0.117	0.172	0.238	0.314	0.401	0.498
		Static Pressure (in. w.g.)	0.005	0.013	0.024	0.039	0.057	0.079	0.104	0.133	0.165
	2 Slot 12" Inlet	Sound (NC)	-	-	15	22	28	32	36	40	43
		Throw (ft)	1-1-5	2-3-14	3-6-26	5-10-33	7-15-38	9-21-41	12-27-44	16-30-47	20-34-49
		Flow Rate (cfm)	220	355	490	625	760	895	1030	1165	1300
2 Slot 12" Inlet	Total Pressure (in. w.g.)	0.008	0.020	0.039	0.063	0.094	0.130	0.172	0.220	0.274	
	Static Pressure (in. w.g.)	0.003	0.008	0.015	0.024	0.035	0.049	0.065	0.083	0.103	
	Sound (NC)	-	-	-	-	20	25	29	32	35	
2 Slot 12" Inlet	Throw (ft)	1-1-5	2-4-14	3-7-26	5-11-34	7-16-38	10-22-42	13-28-45	17-31-47	21-35-50	
	Flow Rate (cfm)	260	390	520	650	780	910	1040	1170	1300	
	Total Pressure (in. w.g.)	0.021	0.047	0.083	0.130	0.187	0.255	0.333	0.421	0.520	
3.0 in. Slot Width	2 Slot 10" Inlet	Static Pressure (in. w.g.)	0.007	0.015	0.026	0.041	0.060	0.081	0.106	0.134	0.165
		Sound (NC)	-	-	18	24	29	34	37	41	44
		Throw (ft)	1-1-5	1-3-12	2-5-22	4-8-32	5-12-38	7-17-41	10-22-44	12-27-46	15-32-49
	2 Slot 12" Inlet	Flow Rate (cfm)	260	390	520	650	780	910	1040	1170	1300
		Total Pressure (in. w.g.)	0.011	0.024	0.042	0.066	0.095	0.129	0.168	0.213	0.263
		Static Pressure (in. w.g.)	0.004	0.008	0.015	0.023	0.033	0.045	0.059	0.075	0.092
	2 Slot 12" Inlet	Sound (NC)	-	-	-	15	20	25	29	32	35
		Throw (ft)	1-1-5	1-3-12	2-5-22	4-8-32	5-12-38	7-17-41	10-22-44	12-27-46	15-32-49
		Flow Rate (cfm)	260	390	520	650	780	910	1040	1170	1300
2 Slot 12" Inlet	Total Pressure (in. w.g.)	0.011	0.024	0.042	0.066	0.095	0.129	0.168	0.213	0.263	
	Static Pressure (in. w.g.)	0.004	0.008	0.015	0.023	0.033	0.045	0.059	0.075	0.092	
	Sound (NC)	-	-	-	15	20	25	29	32	35	
2 Slot 12" Inlet	Throw (ft)	1-1-5	1-3-12	2-5-22	4-8-32	5-12-38	7-17-41	10-22-44	12-27-46	15-32-49	

Performance Notes:

- Testing in accordance with ASHRAE Standard 70-2006 "Method of Testing for Rating the Performance of Air Outlets and Inlets."
- Data is based on Jetlot complete with Price Engineered Plenums (insulated) as a composite assembly.
- Plenums not provided by Price may demonstrate performance variations from data published by Price. Price cannot guarantee performance if a factory engineered plenum is not provided.
- All pressures are in in. w.g.
- Throw values are given for terminal velocities of 150 fpm (minimum), 100 fpm (middle) and 50 fpm (maximum).
- Throw data based on supply air and room air being at isothermal conditions.
- Throw values are based on pattern controllers set 100% open.
- NC values are based on a room absorption of 10 dB re 10⁻¹² watts and one diffuser.
- Blanks "-" indicate an NC level below 15.



Product Improvement is a continuing endeavour at Price. Therefore, specifications are subject to change without notice. Consult your Price Sales Representative for current specifications or more detailed information. Not all products may be available in all geographic areas. All goods described in this document are warranted as described in the Limited Warranty shown at priceindustries.com. The complete Price product catalog can be viewed online at priceindustries.com.